

Singer 68-39

FORM 18517 REVISED
NOVEMBER, 1936
PRINTED IN U. S. A.

LIST
OF
PARTS



MACHINE No. 68-39

THE SINGER MANUFACTURING COMPANY

INSTRUCTIONS FOR OILING

Oil should be applied to all oil holes and at all places where there are parts in movable contact. When the machine is in continuous use, it should be oiled at least twice each day. The loose pulley at the end of the machine must be oiled frequently through the hole in the center of the large screw head at the end of the shaft.

The shuttle bearing in the shuttle race should be oiled each time a bobbin is replaced.

Use only Singer "Oil for High Speed Sewing Machines (Cloth and Leather)" for general use, or "Stainless Oil for High Speed Sewing Machines" where a stainless oil is desired.

INDEX

	Page
Attachments and Accessories.....	16
Bobbin Winder.....	17
Machine Base.....	16
Machine No. 68-39.....	5
Numerical List of Parts.....	21
Obsolete Parts.....	20
Protector.....	17
Starting Lever and Foot Lifter Parts.....	18
Starting Lever Rock Shaft.....	19
Table Belt Guide.....	19
Thread Unwinder.....	16

Copyright, U. S. A., 1916, 1917, 1922, 1923, 1926, 1930, 1931,
1933 and 1935, by The Singer Manufacturing Co.
All Rights Reserved for all Countries

INSTRUCTIONS FOR ORDERING

In ordering from this list, use ONLY the part NUMBER in the FIRST column.

The number stamped on a Sewing Machine Part is in every case the number of the single part only.

Every combination of parts sent out as such has its specific number, which, although not stamped on the parts, must be used when ordering the combination.

Each number always indicates the SAME PART in whatever list it appears, or for whatever machine.

The letters after some of the numbers indicate the style of finish only, as follows:

A-Hardened, Polished, Nickel Plated and Buffed

B-Polished, Nickel Plated and Buffed

C-Hardened Only

D-Polished Only

E-Soft, Not Polished

F-Hardened and Polished

G-Bright Rumbled and Nickel Plated

H-Blued

J-Nickel Plated Only

K-Hardened and Nickel Plated

L-Brass Plated

M-Oxidized

N-Japanned, Dull

P-Japanned, Bright

R-Merlized

T-Copper Plated

T.A-Hardened, Polished, Copper and Nickel Plated and Buffed

T.B-Copper and Nickel Plated and Polished

T.J-Copper and Nickel Plated Only

T.K-Hardened, Copper and Nickel Plated

T.M-Copper Plated and Oxidized

T.L-Copper and Brass Plated

U-Zinc Plated

V-Silver Plated

W-Polished and Nickel Plated

Y-Black Nickel Plated Only

Z-Chromium Plated

Z.B-Polished, Nickel Plated, Buffed and Chromium Plated

Z.J-Nickel and Chromium Plated

These letters MUST BE USED when they appear in the list; and AFTER the number as in the list.

In this series:

1 to 1500, 50001 to 51500 and 140001 to 142000 are Screw Numbers

1501 to 1800 and 51501 to 51800 are Nut Numbers

1801 to 2000 and 51801 to 52000 are Roller Numbers

2001 to 50000 and 52001 to 140000 and 142001 to

190000 are Sewing Machine Parts, 190001 and upward

are numbers of Electrical Parts

The figures in the second column refer only to the plates, illustrating the parts, and are NOT TO BE USED in ordering.

Parts marked with an asterisk (*) are furnished only when repairs are made at factory.

LIST OF PARTS COMPLETE FOR

5

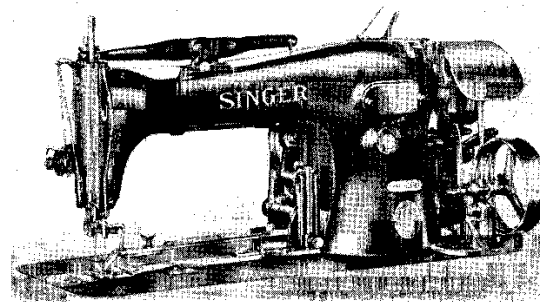

MACHINE No. 68-39

FOR TACKING BELT LOOPS ON TROUSERS, KNICKERBOCKERS, ETC.
MAKES A TACK 1/4 TO 1/2 IN. LONG CONSISTING OF 28 STITCHES,
INCLUDING THE THREE TYING STITCHES.

No.	Plate	Name
*63990	-----	Arm with 4449, 15404, 17844 and two each 164E and 15405.....
2002	3722	Arm Dowel Pin.....
4448	3722	" Oil Tube for intermediate bearing....
880E	3724	" Screw.....
17702	20326	" Shaft.....
*55440	-----	" " 17702 with 55302 and 68717.....
17703	3711	" " Bushing (back).....
50333C	20331	" " " " Adjusting Screw.
1520J	3724	" " " " " " "
		Nut.....
*4449	-----	Arm Shaft Bushing (front).....
124674	20328	" Side Cover.....
190J	3710	" " " " Screw.....
*17704	-----	Bed.....
18498	20326	Belt Cover.....
39290	3774	" " " " Bracket with 134E and 17741...
184E	3778	" " " " Screw Stud.....
17741	20331	" " " " Stud.....
217J	3778	" " " " Screw.....
39222	3774	" Shifter.....
63976	7235	" " " " Clamp.....

From the library of: Diamond Needle Corp

No.	Plate	Name
1255J	3776	Belt Shifter Clamp Screw.....
17927	7248	Clamp Arm with 17714 and 63798.....
17710	20328	" " Hinge Plate.....
1176J	20331	" " " " Screw.....
63798	20327	" " Hook.....
64000	7247	" Foot with 1220F, 17928, 68701, 68702 and two 337J.....
68701	7247	Clamp Foot Belt Loop Guide (back).....
68702	7247	" " " " (front).....
337J	3718	" " " " " Screw.....
17708	3710	" Lifter with 17966.....
190J	3710	" " " " " Screw.....
17928	20336	" Position Stud.....
17712	3710	" Pressure Spring.....
17713	3710	" " " " Bracket.....
1177J	3710	" " " " " Screw.....
17714	20328	" " " " Guide Block.....
1179J	3710	" " " " " Screw.....
1220F	20331	" Screw Stud.....
1656J	20331	" Thumb Nut.....
68703	-----	Clamp complete, Nos. 1656J, 17927 and 6400C
4292	3711	Crank Connecting Rod with two 145E.....
145E	3779	" " " " Cap Screw.....
375C	3724	" " " " Hinge Screw.....
1518E	3718	" " " " " Nut.....
17724	3711	Face Plate.....
*63736	-----	" " 17724 with 2105.....
✓17725	-----	Face Plate complete, Nos. 448C, 2107, 2127, 56791, 63736 and two 233J.....
164J	3724	Face Plate Screw.....
2107	3722	" " Thread Guard.....
233J	3722	" " " " " Screw.....
17726	20327	Feed Across Connection Adjusting Stud....
1649C	20331	" " " " " Nut (left).....
1650C	20331	Feed Across Connection Adjusting Stud Nut (right).....
896E	7235	Feed Across Connection Cap Screw.....
63940	7235	" " " " (lever end) with two 896E.....
63941	-----	Feed Across Connection (lever end) 63940 with 55381.....
55381	7235	Feed Across Connection (lever end) Ball Stud.....
1185C	20331	Feed Across Connection (lever end) Ball Stud Set Screw.....
63942	7235	Feed Across Connection (regulator end) with two 896E.....

No.	Plate	Name
63943	-----	Feed Across Connection (regulator end) 63942 with 63944.....
63944	7235	Feed Across Connection (regulator end) Ball Stud.....
17729	3713	Feed Across Lever with 1185C and 1952....
17731	3713	" " " " Bracket with 17732 and three 160J.....
*17732	-----	Feed Across Lever Bracket Cap.....
180J	7009	" " " " " Screw.....
8589	3722	" " " " " Dowel Pin.....
1177E	3710	" " " " " Screw.....
17737	20327	" " " " Hinge Stud.....
160J	7009	" " " " " Clamping Screw.....
1952	20331	Feed Across Lever Roller and Stud.....
17735	20327	" " Plate with 17741.....
1186C	3781	" " " " " Screw.....
1851J	20331	" " " " " Nut.....
17736	3713	" " Regulator.....
50599D	7235	" " " " Adjusting Screw Stud.....
1676C	3778	Feed Across Regulator Adjusting Screw Stud Nut.....
46244	7235	Feed Across Regulator Adjusting Screw Stud Nut Washer (fibre).....
17738	20328	Feed Across Regulator Adjusting Screw Stud Nut Washer (steel).....
1188D	3724	Feed Across Regulator Hinge Screw.....
17740	20327	" " " " Link.....
1189E	20331	" " " " " Screw Stud....
17741	20331	" " " " " Stud.....
68704	7248	" Cam with 17874 and two each 190J and 1192C (double nipper depression).....
1791		Note: Feed Cam No. 68704 is regularly furnished with this Machine.
68707	7248	Feed Cam with 17874 and two each 190J and 1192C (single nipper depression).....
124925	7248	Feed Cam Driving Worm with 1441C and 1442C.....
1442C	3778	Feed Cam Driving Worm Position Screw....
1441C	3778	" " " " " Set Screw.....
124926	7248	" " " " " Wheel with 453C....
18384	3753	" " " " " Pin.....
453C	20331	" " " " " Set Screw....
18384	3753	" " Pin.....
1192C	3724	" " Set Screw.....
62155	7246	" " Shaft.....
124927	-----	" " " " 62155 with 1653C and 124926

No.	Plate	Name
1653C	3724	Feed Cam Shaft Nut.....
68705	7247	" Plate with 240J and 68706.....
68706	7247	" " Belt Loop Stop.....
240J	7247	" " " " " Screw.....
*39259	3716	" " Carrier Bar.....
39260	-----	" " " " " 39259 with 934J, 1195E,8505,17743,17802,17804,18368, two 7476 and four 17806.....
17802	7247	Feed Plate Carrier Bar Block.....
17803	7247	" " " " " Cover.....
17804	20331	" " " " " Rivet.....
7476	20331	" " " " " Steady Pin...
17805	20327	" " " " " Pivot Block.....
1194D	20331	" " " " " Screw...
18368	7247	" " " " " Plate.....
934J	20331	" " " " " Screw.....
1654C	20331	" " " " " Nut.....
17806	20331	" " " " " Position Stud.....
1195E	20331	" " " " " Screw Stud.....
8505	20336	" " " " " Position Rivet.....
17742	3713	" Regulator with 1953.....
17744	20327	" " Hinge Stud.....
17743	20327	" " Post.....
1953	20331	" " Roller and Screw Stud with 1655C and 37310.....
1655C	20331	Feed Regulator Roller and Screw Stud Nut..
37310	20336	" " " " " " " Washer.....
1190C	20331	Feed Regulator Stop Screw.....
17745	20327	" " Swivel.....
1191D	20331	" " Thumb Screw.....
68708	20336	Knife (needle thread).....
17806	3717	" (shuttle thread).....
*63806	-----	" Bar.....
63807	-----	" " 63806 with 63808,63809 and two 17814.....
39299	3774	Knife Bar 63807 with 704C and 39300.....
17810	20328	" " Cap (back).....
690E	20331	" " " " " Screw.....
17811	20328	" " " " " (front).....
160E	7009	" " " " " Screw.....
39262	3776	" " " " " (intermediate).....
39263	-----	" " " " " 39262 with 1328E,1517J,39264 and 39265.....
690E	20331	Knife Bar Cap (intermediate) Screw.....
39264	3776	" " " " " Stop Pin.....
1328E	3776	" " " " " Screw Bushings.....

No.	Plate	Name
1517J	3776	Knife Bar Cap (intermediate) Stop Pin Screw Bushing Nut.....
39265	3776	Knife Bar Cap (intermediate) Stop Pin Spring.....
63808	20328	Knife Bar Connection.....
17814	20331	" " " " Rivet.....
17915	20329	" " " " Slide Block.....
63809	-----	" " " " " 17915 with 63810.....
63810	20329	Knife Bar Connection Slide Block Stud....
39297	3753	" " Driving Lever with 190J,1420E, 17919 and 39298.....
1322F	3778	Knife Bar Driving Lever Hinge Screw.....
1681C	3778	" " " " " Nut...
39298	3753	" " " " " Lock Stud.....
17919	20327	" " " " " Spring.
190J	3710	" " " " " " " Screw.....
1420E	3753	Knife Bar Driving Lever Lock Stud Stop Screw.....
17820	3716	Knife Bar Extension.....
17750	-----	" " " " " 17820 with 17821 and two 17822.....
190E	3710	Knife Bar Extension Screw.....
7071	20329	" " " " " Washer.....
17821	3717	" " Rack.....
17822	3717	" " " Rivet.....
39300	3776	" " Stop Block.....
19793	20331	" " " Dowel Pin.....
704C	3776	" " " " " Screw.....
39235	7248	" Cam Lever Body.....
39409	-----	" " " " " 39235 with 39460.....
39329	-----	Knife Cam Lever complete, Nos. 19793 and 39409.....
39332	3774	Knife Cam Lever Bracket with 1177J.....
8589	3722	" " " " " Dowel Pin.....
1177J	3710	" " " " " Screw.....
50029C	3776	" " " " " Hinge Screw.....
18471	3776	" " " " " Bushing.....
*18472	-----	" " " " " " " 18471 with 50029C.....
1177J	3710	Knife Cam Lever Hinge Screw Bushing Clamp- ing Screw.....
1980	3778	Knife Cam Lever Roller and Screw Stud with 1654C.....
1654C	20331	Knife Cam Lever Roller and Screw Stud Nut.
39330	3776	" " " " " Slide with 1980.....
39460	-----	" " " " " 39330 with 1255J and 39331.....

No.	Plate	Name
1255J	3776	Knife Cam Lever Slide Screw.....
39331	3776	" " " " Washer.....
19793	20331	" " " " Steady Pin.....
68710	20329	Knife Holder.....
39269	20329	" 68710 with 1336C, 17826, 17830 and two 7298.....
63844	-----	Knife Holder 39269 with 1198C, 17808, 17829 and 68708.....
17826	3717	Knife Holder Pinion.....
7298	3717	" " " Dowel Pin.....
17827	3717	" " " Stud.....
39270	20328	" " " Bracket with 17827
50018F	3778	" " " " Screw.....
1698C	3778	" " " " Nut.
1198C	3717	" Screw.....
17829	3717	" Thread Holder.....
17830	3717	" " Position Pin.....
39291	20329	" " Retainer with 39277 and two 39278.....
39277	20329	Knife Thread Retainer Finger.....
39278	20331	" " Rivet.....
1336C	20331	" " Screw Stud.....
17831	3716	Needle Bar with 237F.....
39203	3718	" " Connecting Link.....
63756	-----	" " " 39203 with 21629
377C	3718	" " " Hinge Screw.....
1518E	3718	" " " Nut.
21629	3718	" " " Stud with 155C.....
155C	3781	" " " Set Screw.....
39350	7249	" " Thread Nipper Driving Lever (adjustable) with 39351 and two 335J..
39351	3776	Needle Bar Thread Nipper Driving Lever Ex- tension.....
335J	3776	Needle Bar Thread Nipper Driving Lever Ex- tension Screw.....
1196F	3721	Needle Bar Thread Nipper Driving Lever Hinge Screw.....
39352	7249	Needle Bar Thread Nipper Driving Lever Spring.....
17834	3718	Needle Bar Thread Nipper Lever with 17835.
17835	3718	" " " Bushing....
1200J	3718	" " " Hinge Screw
39276	3776	" " " Spring.....
1329J	3776	" " " Screw
17837	3716	" " " Rod.....
17838	3718	" " " Adjusting Stud
1651E	20331	" " " Lock Nut.....

No.	Plate	Name
17839	3718	Needle Bar Thread Nipper Rod Arm with 196F
196F	3718	" " " " " Set Screw
17840	3716	" " " " " Support.....
190J	3710	" " " " " Screw.
237F	7009	" Set Screw.....
4304	3711	Oscillating Rock Shaft with 4784.....
3052	3711	" " " Hinge Pin.....
1513J	3724	" " " Nut.....
635C	20331	" " " Screw
		Bearing.....
1513J	3724	Oscillating Rock Shaft Hinge Pin Screw
		Bearing Nut.....
4784	20329	Oscillating Rock Shaft Oil Pad.....
3168	7211	" Shaft.....
*56767	-----	" 3168 with 2049, 2542 and 15164.....
15163	-----	Oscillating Shaft Crank for 15164.....
15426	-----	" " " 15165.....
*15164	-----	Oscillating Shaft Crank complete, Nos. 462C 1519E, 15163 and 15171.....
15165	20329	Oscillating Shaft Crank complete, Nos. 1519E, 15171, 15426 and two 462C.....
2049	20331	Oscillating Shaft Crank Pin.....
462C	20331	" " " Set Screw.....
15170	20329	" " " Slide Block.....
226J	20331	" " " Cap
		Screw.....
12424	20329	Oscillating Shaft Crank Slide Block Cap
		Screw Washer.....
1035C	20329	Oscillating Shaft Crank Slide Block Screw
		Stud.....
1519E	20331	Oscillating Shaft Crank Slide Block Screw
		Stud Nut.....
15171	-----	Oscillating Shaft Crank Slide Block com- plete, Nos. 226J, 1035C, 12424 and 15170
2058	3716	Presser Bar.....
17841	3718	" " Collar with two 196F.....
196F	3718	" " " Set Screw.....
17842	3718	" " Guide Bracket with 453C.....
453C	20331	" " " Set Screw.....
17843	3711	" " Lifting Lever.....
17844	3711	" " " Bracket.....
164E	3724	" " " Screw...
1201C	20331	" " " Hinge Screw.....
17845	3716	" " " Rod.....
17846	-----	" " " Chain.....
32675	20336	" " Spring.....
68712	20337	Pulley (loose) 2 3/4 in. diam. with 200584D.....

PARTS FOR MACHINE 68-39

No.	Plate	Name
68713	-----	Pulley (loose) 68712 with 68714.....
68714	20337	" " " Ball Bearing.....
68715	20336	" " " Bushing.....
51387R	20336	" " " Cap Screw.....
200584D	20336	" " " Oil Plug Screw.....
68716	20337	" (tight) 2 7/8 in. diam.....
68720	-----	" " " 68716 with 1206C and 17854.
2022	3722	" " " Pin.....
68717	-----	Pulleys (ball bearing) complete, Nos. 51387R, 68713, 68715 and 68720.....
2996	7214	Shuttle Bobbin.....
*33941	-----	" " " Case.....
15140	7214	" " " Latch.....
2973	7214	" " " Lever.....
2974	7214	" " " Fulcrum Pin.....
2975	7214	Shuttle Bobbin Case Latch Spring.....
592E	7214	" " " Stop Screw.....
15141	-----	" " " Hinge, Nos. 2973, 2974 and 15140.....
7553	7214	Shuttle Bobbin Case Position Finger.....
2523	7214	" " " Rivet..
33942	7235	Shuttle Bobbin Case complete, Nos. 591F, 592E, 2523, 2975, 7553, 15141, 15278 and 33941.....
24412	7214	Shuttle Bobbin Case Position Plate.....
391J	7214	" " " Screw...
2515	7214	" " Body.....
591F	7214	" " Tension Regulating Screw.....
15278	7235	" " Spring.....
63535	20329	" " 1 11/16 in. diam., Nos. 2515, 2996 and 33942.....
*2542	-----	Shuttle Driver.....
2441	7214	" " 2542 with two 462C.....
2049	20331	" " Pin.....
462C	20331	" " Set Screw.....
2531	7211	" " Race Back.....
2532	7214	" " Position Pin.....
2533	7211	" " Spring.....
907D	7214	" " Screw.....
63840	-----	" " Body.....
63946	-----	" " 63840 with 1053J, 2523 and 63841.....
63841	20329	Shuttle Race Cap.....
1053J	20331	" " Screw.....
2523	7214	" " Steady Pin.....
63842	7211	Shuttle Race complete, Nos. 907D, 2531, 2533 24412, 63946 and two each 391J and 2532

PARTS FOR MACHINE 68-39

No.	Plate	Name
145E	3778	Shuttle Race Screw.....
17853	7249	Starting Lever.....
1262C	3778	" " " Hinge Screw.....
1662C	3778	" " " Nut.....
17886	3716	" " " Pitman.....
17854	3721	Stop Cam.....
17855	3721	" " Interlocking Rod.....
63977	7246	" " " Case.....
63978	-----	" " " " " 63977 with 18443 and two 193J.....
63993	-----	Stop Cam Interlocking Rod Case 63978 with 63976 and two 1255J.....
*39405	-----	Stop Cam Interlocking Rod Case 63993 with 1318D, 17855, 17863, 17864 and 39222....
39346	7249	Stop Cam Interlocking Rod Case Bracket....
63754	-----	Stop Cam Interlocking Rod Case Bracket complete, Nos. 1182E, 1196C, 1204E, 1254C, 1262C, 1508E, 1662C, 17853, 17859, 17861, 17862, 17872, 17873, 39346, 39405 and two 898J.....
39347	-----	Stop Cam Interlocking Rod Case Bracket 63754 with 39343, 39344 and two 1186J..
16532	3722	Stop Cam Interlocking Rod Case Bracket Dowel Pin.....
1343E	3778	Stop Cam Interlocking Rod Case Bracket Screw.....
	1204E 3721	Stop Cam Interlocking Rod Case Hinge Screw
	17859 20328	" " " Socket Joint.....
	898J 3721	Stop Cam Interlocking Rod Case Socket Joint Cap Screw.....
39343	3774	Stop Cam Interlocking Rod Case Spring (flat).....
50682C	7235	Stop Cam Interlocking Rod Case Spring Ad- justing Screw.....
	1520J 3724	Stop Cam Interlocking Rod Case Spring Ad- justing Screw Nut.....
39344	3776	Stop Cam Interlocking Rod Case Spring Bracket with 1520J and 50682C.....
	1186J 3781	Stop Cam Interlocking Rod Case Spring Bracket Screw.....
	17861 3721	Stop Cam Interlocking Rod Case Stop Stud..
	1254C 3778	" " " " " " " " " " " "
		Screw Bushing.....
	1508J 3778	Stop Cam Interlocking Rod Case Stop Stud Screw Bushing Lock Nut.....
	17862 3721	Stop Cam Interlocking Rod Case Stop Stud Spring.....

No.	Plate	Name
18443	3754	Stop Cam Interlocking Rod Case Wearing Block.....
193J	20331	Stop Cam Interlocking Rod Case Wearing Block Screw.....
17863	3721	Stop Cam Interlocking Rod Spring.....
17864	3721	" " " " Stop.....
1318D	20331	" " " " Screw.....
3012	3722	" " Pin.....
1206C	3721	" " Screw.....
2102	3722	Tension Disc.....
1560C	3722	" Regulating Thumb Nut.....
600C	3722	" Screw Stud.....
16202	-----	" " " 600C with 1560C.....
448C	3722	" " " Set Screw.....
2103	3722	" Spring.....
2105	3722	" Thread Guard.....
56791	-----	Tension complete, Nos. 2103, 2124, 16202 and two 2102.....
*55302	-----	Thread Take-up Cam.....
18392	7211	" " " 55302 with 446C.....
3012	3722	" " Pin.....
446C	3724	" " Set Screw.....
18393	7249	" " Lever with 1822.....
55283	-----	" " " 18393 with 79F.....
79F	3753	" " Hinge Screw.....
1822	3753	" " Roller and Stud.....
2124	3722	" " Spring.....
2127	3722	" " Regulator Plate.....
233J	3722	" " " " Ad-justing Screw.....
17865	3710	Thread Wiper Body.....
1207D	20331	" " " Hinge Screw.....
17866	3710	" " " Hook.....
17867	3710	" " " Support.....
641C	3778	" " " Set Screw.....
17868	3710	" " " Wire.....
337J	3718	" " " Screw.....
17869	3710	" " " Washer.....
63997	20330	Throat Plate Body.....
63786	20330	" " 63997 with 17749, 39486 and two each 1208D and 50406J.....
63845	-----	Throat Plate 63786 with 1698C, 39270, 39291 50018F and 63844.....
17749	20330	Throat Plate Extension.....
50406J	20331	" " " Screw.....
39486	7214	" " Needle Hole Bushing.....
1208D	20331	" " " " " Screw.....
691F	3724	" " " " " Screw.....

No.	Plate	Name
*15404	-----	Trade Mark.....
15405	-----	" " Rivet.....
17872	3721	Trip Lever.....
1196C	3721	" " Hinge Screw.....
17873	3721	" " Spring.....
1182E	20331	" " Screw.....
17874	3717	Tripping Point.....
190J	3710	" " Screw.....

Genuine Singer Needles should be used
in Singer Machines.
These Needles and their Containers
are marked with the
Company's Trade Mark "SIMANCO."

Needles in Containers marked
"For Singer Machines"
are not Singer made needles.

MACHINE BASE

No.	Plate	Name
39483	7214	Bed Frame Cushion (leather).....
39325	3776	" " Hinge Connection.....
9261	3776	" " " " Pin.....
453C	20331	" " " " Set Screw.....
39232	3749	" " Side Cover.....
39233	3749	" " with 39232, two each 9261,39325 39483 and four wood screws 1 1/4 in., No. 12.....
39234	3750	Drip Pan.....

ATTACHMENTS AND ACCESSORIES

No.	Plate	Name
120346	20338	Oiler (copper plated) with 120347.....
120347	20338	" Spout, 9 in. long.....
41401	7231	Machine Rest Pin (wood) 5 11/16 in. long.
11831	7231	Screw Driver (large).....
26026	20338	" " (medium).....
26485	20338	" " (small).....
17875	20326	Table Bracket Machine Holder with 2809, 7263,39484 and two wood screws 1 1/4 in. No. 10.....
7263	3718	Table Bracket Machine Holder Connection..
2809	3718	" " " " Hinge Pin.....
453C	20331	Table Bracket Machine Holder Connection Set Screw.....
39484	3718	Table Bracket Machine Holder Cushion (leather).....
120341	20338	Tweezers (curved).....
4822	20338	Wrench for 1698.....
10875	20338	" " 1517,1518,1519,1520,1649, 1650 and 1662.....
17905	20338	Wrench for 1178,1654,1655,1676 and 1681..
22003	20338	" " 1651.....
27682	20338	" " 1254 and 1508.....

BOBBIN WINDER

(SWINGING AUTOMATIC, LEFT HAND)

FOR 2996

No.	Plate	Name
41598	8579	Base with 27916 and two 28084.....
1186C	3781	" Screw.....
15072	20331	Bobbin Position Pin.....
27916	3781	Brake (leather).....
28084	3781	" Rivet.....
27321	3781	Frame.....
50356D	3781	" Hinge Screw.....
1620J	3781	" " Nut.....
41825	3781	" Spring.....
41800	8579	Pulley with 155C.....
155C	3781	" Set Screw.....
*27849	-----	Spindle.....
27538	8579	" 27849 with 15072,27850 and 41828.
*27850	-----	" Collar.....
41828	-----	" " Pin.....
27328	8579	Stop Latch.....
35D	3781	" " Hinge Screw.....
60769	8579	Tension Bracket.....
60770	8579	Tension Bracket complete, Nos. 419E,1562J 8422,9780,43808,60769 and two 2455...
9780	3781	Tension Bracket Position Stud.....
161J	3781	" " Screw.....
2455	3781	" Disc.....
419E	3781	" Screw Stud.....
1562J	3781	" Regulating Thumb Nut.....
43808	3781	" Spring.....
8422	3781	" Thread Guide.....
41604	8579	Bobbin Winder, Nos. 35D,1620J,27321,27328 27538,41598,41600,41825 and 50356D...
41716	-----	Bobbin Winder (swinging automatic, left hand) complete, Nos. 161J,41604,60770 and two 1186C.....

PROTECTOR

No.	Plate	Name
39489	7008	Arm with 39490.....
160C	7009	" Clamping Screw.....
39490	-----	Blade.....
39491	7008	Bracket with two each 426C and 446C.....

No.	Plate	Name
426C	7009	Bracket Adjusting Screw.....
50351J	7009	" Screw.....
39492	7009	Crank with 160C.....
39493	7009	" Bracket with 1120C and two 454C....
454C	7009	" Set Screw.....
52598	7009	" Hinge Stud.....
1120C	7009	" Set Screw.....
39494	7008	Rod.....
15261	7009	" Collar with 237F.....
237F	7009	" Set Screw.....
39495	7009	" Connection.....
176J	7009	" Screw.....
1099F	7009	" Screw Stud.....
39496	7008	" Sleeve.....
448C	7009	" Set Screw.....
39497	7009	" Spring.....
15261	7009	" Collar with 237F.....
237F	7009	" Set Screw.....
63753	-----	Protector (front of needle) Nos. 1099F, 39489, 39491 to 39494, 39496, 39497, 52598 and two 15261.....
39498	-----	Protector (front of needle) complete, Nos. 39495, 63753 and two each 176J and 50351J.....

STARTING LEVER AND FOOT LIFTER PARTS

No.	Plate	Name
6439	-----	Chain, 36 in. to 45 in., with 56864 and 56865, for stand.....
Note: When ordering No. 6439, state length required		
56864	7231	Chain Hook (large).....
56865	7235	" " (small).....
17376	3728	Treadle with 443C.....
17377	3728	" Pitman Rod (lower).....
17378	3728	" " (upper).....
17879	3728	" " Clamp with two 161E....
161E	3724	" " Screw.....
17880	3728	Treadle Pitman complete, Nos. 17877 to 17879.....
17881	3716	Treadle Shaft.....
443C	-----	" Set Screw.....
17882	3718	" Spring.....
17883	3728	" Stand.....
17884	-----	Treadle complete, Nos. 17876, 17881 to 17883 and two wood screws 1 in. No. 10
17885	-----	Treadle and Pitman complete, for power table, Nos. 17880 and 17884.....

STARTING LEVER ROCK SHAFT

FOR STAND NO. 25297

No.	Plate	Name
14224	-----	Chain, length 10 1/4 in., with 56864.....
56864	7231	" Hook.....
7124	7242	Rock Shaft.....
27683	7242	" " Arm with two 356C.....
356C	20336	" " Set Screw.....
16128	7242	" " Hanger with two wood screws... 1 in. No. 10.....
32134	20336	Rock Shaft Spring.....
2770	7242	" " Stop Dog with 356C.....
356C	20336	" " Set Screw.....
63981	-----	Starting Lever Rock Shaft complete, Nos. 7124, 14224, 32134 and two each 2770, 16128 and 27683.....

TABLE BELT GUIDE

No.	Plate	Name
39218	3728	Belt Guide with two 168E.....
168E	-----	" " Set Screw.....
17892	3728	Bracket with two 153E.....
17893	3728	Pulley.....
39219	3728	" Shaft (long) with 17396 and 63973.
63973	7246	" " Wick (braided cotton)
39220	3728	" " (short) with 17896 and 63974
63974	7246	" " Wick (braided cotton)
17896	3718	" " Plug.....
153E	3724	" " Set Screw.....
39221	-----	Table Belt Guide complete, Nos. 17892, 39219, 39220, two each 17893, 39218 and three wood screws 1 1/4 in. No. 12...

THREAD UNWINDER

(FOR TWO SPOOLS)

No.	Plate	Name
225257	20335	Spool Rest (for two spools) with 201018C.
150203	20335	" " Cushion (felt).....
225388	20335	" " Rod.....
200383C	7235	" " Set Screw.....
201018C	7235	" " Set Screw.....
202490	20335	" Stand with 200383C.....
225391	20335	Thread Guide.....

THREAD UNWINDER

No.	Plate	Name
201696J	7235	Thread Guide Lock Nut.....
225326	20335	" " Position Cup.....
225324	20335	" " Rod with 208E and 225322....
208E	3778	" " " Screw.....
225322	20336	" " " Washer.....
225258	20335	Thread Unwinder complete, Nos. 201696J, 202490, 225257, 225324, 225326, 225386, two each 150203, 225391 and three wood screws 7/8 in. No. 12.....
27739	20337	Thread Cone (wood) for large cones.....
225390	20337	" " Holder, for inverted cones...

Note: Nos. 27739 and 225390 are used with, but not included in 225258.

OBSOLETE PARTS

No.	Plate	Name
3012	3722	Feed Cam Driving Worm Wheel Pin.....
14017	20328	" Regulator Roller and Screw Stud Nut Washer, use 37310.....
18389	20329	Knife (needle thread) for 63844, use 68708.....
8414	3716	Presser Bar Spring, use 32675.....
63975	7246	Pulley (loose) 2 3/4 in. diam.....
17848	20328	" " Bushing.....
2269	3722	" " " Position Pin.....
1202R	3724	" " Cap Screw.....
17942	7249	" (tight) 2 7/8 in. diam., with 2269
17955	----	Pulleys complete, Nos. 1202R, 1206C, 17848, 17854, 17942 and 63975, use 68717.....

**Genuine Singer Needles should be used
in Singer Machines.
These Needles and their Containers
are marked with the
Company's Trade Mark "SIMANCO." 1**

**Needles in Containers marked
"For Singer Machines"
are not Singer made needles. 2**

NUMERICAL LIST OF PARTS

NUMERICAL LIST OF PARTS

No.	Plate	Name
35D	3781	Bobbin Winder Stop Latch Hinge Screw for 41604.....
79F	3753	Thread Take-up Lever Hinge Screw for 55283
145E	3778	Crank Connecting Rod Cap Screw for 4292..
145E	3778	Shuttle Race Screw.....
153E	3724	Table Belt Guide Pulley Shaft Set Screw for 17892.....
155C	3781	Bobbin Winder Pulley Set Screw for 41600.
155C	3781	Needle Bar Connecting Stud Set Screw for 21629.....
160J	7009	Feed Across Lever Bracket Cap Screw for 17731.....
160J	7009	Feed Across Lever Hinge Stud Clamping Screw for 17731.....
160E	7009	Knife Bar Cap (front) Screw.....
160C	7009	Protector Arm Clamping Screw for 39492...
161J	3781	Bobbin Winder Tension Bracket Screw for 41716.....
161E	3724	Treadle Pitman Rod Clamp Screw for 17879.
164J	3724	Face Plate Screw.....
164E	3724	Presser Bar Lifting Lever Bracket Screw for 63990.....
168E	-----	Table Belt Guide Set Screw for 39218.....
176J	7009	Protector Rod Connection Screw for 39498.
184E	3778	Belt Cover Bracket Screw Stud for 39290..
190J	3710	Arm Side Cover Screw.....
190J	3710	Clamp Lifter Screw.....
190J	3710	Knife Bar Driving Lever Lock Stud Spring Screw for 39297.....
190E	3710	Knife Bar Extension Screw.....
190J	3710	Needle Bar Thread Nipper Rod Support Screw.....
190J	3710	Tripping Point Screw for 68704 and 68707.
193J	20331	Stop Cam Interlocking Rod Case Wearing Block Screw for 63979.....
196F	3718	Needle Bar Thread Nipper Rod Arm Set Screw for 17839.....
196F	3718	Presser Bar Collar Set Screw for 17941...
208E	3778	Thread Unwinder Thread Guide Rod Screw for 225324.....
217J	3778	Belt Cover Screw.....
226J	20331	Oscillating Shaft Crank Slide Block Cap Screw for 15171.....

No.	Plate	Name
233J	3722	Face Plate Thread Guard Screw for 17725..
233J	3722	Thread Take-up Spring Regulator Plate Ad- justing Screw for 17725.....
237F	7009	Needle Set Screw for 17931.....
237F	7009	Protector Rod Collar Set Screw for 15261.
237F	7009	" " Spring Collar Set Screw for 15261.....
240J	7247	Feed Plate Belt Loop Stop Screw for 68705
335J	3776	Needle Bar Thread Nipper Driving Lever Extension Screw for 39350.....
337J	3718	Clamp Foot Belt Loop Guide Screw for 64000.....
337J	3718	Thread Wiper Body Wire Screw.....
356C	20336	Starting Lever Rock Shaft Arm Set Screw for 27683.....
356C	20336	Starting Lever Rock Shaft Stop Dog Set Screw for 2770.....
375C	3724	Crank Connecting Rod Hinge Screw.....
377C	3713	Needle Bar Connecting Link Hinge Screw...
391J	7214	Shuttle Bobbin Case Position Plate Screw for 63842.....
419E	3791	Bobbin Winder Tension Screw Stud for 60770.....
426C	7009	Protector Bracket Adjusting Screw for 39491.....
443C	-----	Treadle Shaft Set Screw for 17976.....
446C	3724	Thread Take-up Cam Set Screw for 18392..
448C	7009	Protector Rod Sleeve Set Screw for 39491.
448C	3722	Tension Screw Stud Set Screw for 17725...
453C	20331	Feed Cam Driving Worm Wheel Set Screw for 124926.....
453C	20331	Presser Bar Guide Bracket Set Screw for 17842.....
453C	20331	Bed Frame Hinge Connection Set Screw....
453C	20331	Table Bracket Machine Holder Connection Set Screw.....
454C	7009	Protector Crank Bracket Set Screw for 39493.....
462C	20331	Oscillating Shaft Crank Set Screw for 15164 and 15165.....
462C	20331	Shuttle Driver Set Screw for 2441.....
591F	7214	" Tension Regulating Screw for 33942.....
592E	7214	Shuttle Bobbin Case Latch Stop Screw for 33942.....
600C	3722	Tension Screw Stud for 18202.....
635C	20331	Oscillating Rock Shaft Hinge Pin Screw Bearing.....

No.	Plate	Name
841C	3778	Thread Wiper Body Support Set Screw.....
890E	20331	Knife Bar Cap (back) Screw.....
890E	20331	" " " (intermediate) Screw.....
891F	3724	Throat Plate Screw.....
704C	3776	Knife Bar Stop Block Screw for 39299....
880E	3724	Arm Screw.....
896E	7235	Feed Across Connection Cap Screw for 63940 and 63942.....
898J	3721	Stop Cam Interlocking Rod Case Socket Joint Cap Screw for 63754.....
907D	7214	Shuttle Race Back Spring Screw for 63842.
934J	20331	Feed Plate Carrier Bar Plate Screw for 39260.....
1035C	20329	Oscillating Shaft Crank Slide Block Screw Stud for 15171.....
1053J	20331	Shuttle Race Cap Screw for 63946.....
1099F	7009	Protector Rod Screw Stud for 63753.....
1120C	7009	" Crank Hinge Stud Set Screw for 39493.....
1176J	20331	Clamp Arm Hinge Plate Screw.....
1177J	3710	" Pressure Spring Bracket Screw.....
1177E	3710	Feed Across Lever Bracket Screw.....
1177J	3710	Knife Cam Lever Bracket Screw.....
1177J	3710	" " Hinge Screw Bushing Clamp- ing Screw for 39332.....
1178J	3710	Clamp Pressure Spring Screw.....
1182E	20331	Trip Lever Spring Screw for 63754.....
1185C	20331	Feed Across Connection (lever end) Ball Stud Set Screw for 17729.....
1186C	3781	Bobbin Winder Base Screw for 41718.....
1186C	3781	Feed Across Plate Screw.....
1186J	3781	Stop Cam Interlocking Rod Case Spring Bracket Screw for 39347.....
1188D	3724	Feed Across Regulator Hinge Screw.....
1189E	20331	" " " Link Screw Stud....
1190C	20331	" Regulator Stop Screw.....
1191D	20331	" " Thumb Screw.....
1192C	3724	" Cam Set Screw for 68704 and 68707...
1194D	20331	" Plate Carrier Bar Pivot Block Screw.
1195E	20331	" " Screw Stud for 39260.....
1198F	3721	Needle Bar Thread Nipper Driving Lever Hinge Screw.....
1196C	3721	Trip Lever Hinge Screw for 63754.....
1198C	3717	Knife Screw for 63844.....
1200J	3718	Needle Bar Thread Nipper Lever Hinge Screw.....
1201C	20331	Presser Bar Lifting Lever Hinge Screw....
1202R	3724	Pulley (loose) Cap Screw for 17955, obso- lete.....

No.	Plate	Name
1204E	3721	Stop Cam Interlocking Rod Case Hinge Screw for 63754.....
1206C	3721	Stop Cam Screw for 17955 and 68720.....
1207D	20331	Thread Wiper Body Hinge Screw.....
1208D	20331	Throat Plate Needle Hole Bushing Screw for 63786.....
1220F	20331	Clamp Screw Stud for 64000.....
1254C	3778	Stop Cam Interlocking Rod Case Stop Stud Screw Bushing for 63754.....
1255J	3776	Belt Shifter Clamp Screw for 63993.....
1255J	3776	Knife Cam Lever Slide Screw for 39480....
1262C	3778	Starting Lever Hinge Screw for 63754.....
1318D	20331	Stop Cam Interlocking Rod Stop Screw for 39405.....
1328E	3776	Knife Bar Cap (intermediate) Stop Pin Screw Bushing for 39263.....
1329J	3776	Needle Bar Thread Nipper Lever Spring Screw.....
1336C	20331	Knife Thread Retainer Screw Stud for 39289.....
1343E	3778	Stop Cam Interlocking Rod Case Bracket Screw.....
1382F	3778	Knife Bar Driving Lever Hinge Screw.....
1420E	3753	" " " Lock Stud Stop Screw for 39297.....
1441C	3778	Feed Cam Driving Worm Set Screw for 124925.....
1442C	3778	Feed Cam Driving Worm Position Screw for 124925.....
1508J	3778	Stop Cam Interlocking Rod Case Stop Stud Screw Bushing Lock Nut for 63754.....
1513J	3724	Oscillating Rock Shaft Hinge Pin Nut....
1513J	3724	" " " Screw... Bearing Nut.....
1517J	3776	Knife Bar Cap (intermediate) Stop Pin Screw Bushing Nut for 39263.....
1518E	3718	Crank Connecting Rod Hinge Screw Nut....
1518E	3718	Needle Bar Connecting Link Hinge Screw Nut.....
1519E	20331	Oscillating Shaft Crank Slide Block Screw Stud Nut for 15164 and 15165.....
1520J	3724	Arm Shaft Bushing (back) Adjusting Screw Nut.....
1520J	3724	Stop Cam Interlocking Rod Case Spring Adjusting Screw Nut for 39344.....
1560C	3722	Tension Regulating Thumb Nut for 16202....
1562J	3781	Bobbin Winder Tension Regulating Thumb Nut for 60770.....

No.	Plate	Name
1620J	3781	Bobbin Winder Frame Hinge Screw Nut for 41604.....
1649C	20331	Feed Across Connection Adjusting Stud Nut (left).....
1650C	20331	Feed Across Connection Adjusting Stud Nut (right).....
1651J	20331	Feed Across Plate Screw Nut.....
1651E	20331	Needle Bar Thread Nipper Rod Adjusting Stud Lock Nut.....
1653C	3724	Feed Cam Shaft Nut for 124927.....
1654C	20331	" Plate Nut.....
1654C	20331	Knife Cam Lever Roller and Screw Stud Nut for 1980.....
1655C	20331	Feed Regulator Roller and Screw Stud Nut for 1953.....
1656J	20331	Clamp Thumb Nut for 68703.....
1662C	3778	Starting Lever Hinge Screw Nut for 63754.
1678C	3778	Feed Across Regulator Adjusting Screw Stud Nut.....
1681C	3778	Knife Bar Driving Lever Hinge Screw Nut..
1698C	3778	" Holder Pinion Stud Bracket Screw Nut for 63845.....
1822	3753	Thread Take-up Lever Roller and Stud for 18393.....
1952	20331	Feed Across Lever Roller and Stud for 17729.....
1953	20331	Feed Regulator Roller and Screw Stud with 1655C and 37310, for 17742.....
1980	3776	Knife Cam Lever Roller and Screw Stud with 1654C, for 39330.....
2002	3722	Arm Dowel Pin.....
2022	3722	Pulley (tight) Pin.....
2049	20331	Oscillating Shaft Crank Pin for 56767....
2049	20331	Shuttle Driver Pin.....
2058	3716	Presser Bar.....
2102	3722	Tension Disc for 56791.....
2103	3722	" Spring for 56791.....
2105	3722	" Thread Guard for 63736.....
2107	3722	Face Plate Thread Guard for 17725.....
2124	3722	Thread Take-up Spring for 56791.....
2127	3722	" " Regulator Plate for 17725.....
2269	3722	Pulley (loose) Bushing Position Pin for 17942, obsolete.....
2441	7214	Shuttle Driver 2542 with two 462C.....
2455	3781	Bobbin Winder Tension Disc for 60770.....
2515	7214	Shuttle Body for 63535.....
2523	7214	" Bobbin Case Position Finger Rivet for 33942.....

No.	Plate	Name
2523	7214	Shuttle Race Cap Steady Pin for 63946....
2531	7211	" " Back for 63842.....
2532	7214	" " " Position Pin for 63842.
2533	7211	" " " Spring for 63842.....
*2542	-----	Driver for 2441 and 56767.....
2770	7242	Starting Lever Rock Shaft Stop Dog with 356C, for 63981.....
2809	3718	Table Bracket Machine Holder Connection Hinge Pin for 17875.....
2973	7214	Shuttle Bobbin Case Latch Lever for 15141
2974	7214	" " " " Fulcrum Pin for 15141.....
2975	7214	Shuttle Bobbin Case Latch Spring for 33942.....
2996	7214	Shuttle Bobbin for 63535.....
3012	3722	Feed Cam Driving Worm Wheel Pin, obsolete
3012	3722	Stop Cam Pin.....
3012	3722	Thread Take-up Cam Pin.....
3052	3711	Oscillating Rock Shaft Hinge Pin.....
3168	7211	" Shaft for 56767.....
4292	3711	Crank Connecting Rod with two 145E.....
4304	3711	Oscillating Rock Shaft with 4784.....
4448	3722	Arm Oil Tube for intermediate bearing....
*4449	-----	" Shaft Bushing (front) for 63990.....
4784	20329	Oscillating Rock Shaft Oil Pad for 4304..
4822	20338	Wrench for 1698 (Attachments and Acces- sories).....
6439	-----	Chain, 36 in. to 45 in. with 56864 and 56865, for stand, for 17885.....
7071	20329	Knife Bar Extension Screw Washer.....
7124	7242	Starting Lever Rock Shaft for 63981.....
7263	3718	Table Bracket Machine Holder Connection for 17875.....
7298	3717	Knife Holder Pinion Dowel Pin for 39269..
7476	20331	Feed Plate Carrier Bar Block Steady Pin for 39260.....
7553	7214	Shuttle Bobbin Case Position Finger for 33942.....
8414	3716	Presser Bar Spring, obsolete, use 32675..
8422	3781	Bobbin Winder Tension Thread Guide.....
8505	20336	Feed Plate Screw Stud Position Rivet for 39280.....
8589	3722	Feed Across Lever Bracket Dowel Pin.....
8589	3722	Knife Cam Lever Bracket Dowel Pin.....
9261	3776	Bed Frame Hinge Connection Pin for 39233.
9780	3781	Bobbin Winder Tension Bracket Position Stud for 60770.....
10875	20338	Wrench for 1517,1518,1519,1520,1649,1650 and 1662 (Attachments and Accessories)

No.	Plate	Name
11831	7231	Screw Driver, large (Attachments and Ac- cessories).....
12424	20329	Oscillating Shaft Crank Slide Block Cap Screw Washer for 15171.....
14017	20328	Feed Regulator Roller and Screw Stud Nut Washer for 1953, obsolete, use 37310.
14224	-----	Starting Lever Rock Shaft Chain, length 10 1/4 in. with 56864, for 63981.....
15072	20331	Bobbin Winder Bobbin Position Pin for 27538.....
15140	7214	Shuttle Bobbin Case Latch for 15141.....
15141	-----	" " " Hinge for 33942, Nos. 2973,2974 and 15140.....
15163	-----	Oscillating Shaft Crank for 15164.....
*15164	-----	Oscillating Shaft Crank complete, for 56767, Nos. 462C,1519E,15163 and 15171.....
15165	20329	Oscillating Shaft Crank complete, Nos. 1519E,15171,15426 and two 462C.....
15170	20329	Oscillating Shaft Crank Slide Block for 15171.....
15171	-----	Oscillating Shaft Crank Slide Block com- plete, for 15164 and 15165, Nos. 226J 1035C,12424 and 15170.....
15261	7009	Protector Rod Collar with 237F, for 63753
15261	7009	" " Spring Collar with 237F, for 63753.....
15278	7235	Shuttle Tension Spring for 33942.....
*15404	-----	Trade Mark for 63990.....
15405	-----	" " Rivet for 63990.....
15426	-----	Oscillating Shaft Crank for 15165.....
16128	7242	Starting Lever Rock Shaft Hanger with two wood screws 1 in. No. 10, for 63981..
16202	-----	Tension Screw Stud 600C with 1560C.....
16532	3722	Stop Cam Interlocking Rod Case Bracket... Dowel Pin.....
17702	20326	Arm Shaft for 55440.....
17703	3711	" " Bushing (back).....
*17704	-----	Bed.....
17708	3710	Clamp Lifter with 17866.....
17710	20328	" Arm Hinge Plate.....
17712	3710	" Pressure Spring.....
17713	3710	" " Bracket.....
17714	20328	" " " Guide Block for 17927.....
17724	3711	Face Plate for 63736.....
17725	-----	Face Plate complete, Nos. 448C,2107,2127, 56791,63736 and two 233J.....

No.	Plate	Name
17726	20327	Feed Across Connection Adjusting Stud....
17729	3713	" " Lever with 1185C and 1952....
17731	3713	" " " Bracket with 17732 and three 180J.....
*17732	-----	Feed Across Lever Bracket Cap for 17731..
17735	20327	" " Plate with 17741.....
17736	3713	" " Regulator.....
17737	20327	" " Lever Hinge Stud.....
17738	20328	" " Regulator Adjusting Screw.... Stud Nut Washer (steel).....
17740	20327	Feed Across Regulator Link.....
17741	20331	Belt Cover Bracket Stud for 39290.....
17741	20331	Feed Across Regulator Link Stud for 17735
17742	3713	" Regulator with 1953.....
17743	20327	" " Post for 39260.....
17744	20327	" " Hinge Stud.....
17745	20327	" " Swivel.....
17749	20330	Throat Plate Extension for 63786.....
17750	-----	Knife Bar Extension 17820 with 17821 and two 17822.....
17802	7247	Feed Plate Carrier Bar Block for 39260...
17803	7247	" " " " " Cover.....
17804	20331	" " " " " Rivet for 39260.....
17805	20327	Feed Plate Carrier Bar Pivot Block.....
17806	20331	" " Position Stud for 39260.....
17808	3717	Knife (shuttle thread) for 63844.....
17810	20328	" Bar Cap (back).....
17811	20328	" " (front).....
17814	20331	" " Connection Rivet for 63807.....
17820	3716	" " Extension for 17750.....
17821	3717	" " Rack for 17750.....
17822	3717	" " Rivet for 17750.....
17826	3717	" Holder Pinion for 39269.....
17827	3717	" " Stud for 39270.....
17829	3717	" Thread Holder for 63844.....
17830	3717	" " Position Pin for 39269
17831	3716	Needle Bar with 237F.....
17834	3718	" " Thread Nipper Lever with 17835
17835	3718	" " " " " Bushing for 17834.....
17837	3716	Needle Bar Thread Nipper Rod.....
17838	3718	" " " " " Adjusting Stud.....
17839	3718	Needle Bar Thread Nipper Rod Arm with 196F.....
17840	3716	Needle Bar Thread Nipper Rod Support.....
17841	3718	Presser Bar Collar with two 196F.....

No.	Plate	Name
17842	3718	Presser Bar Guide Bracket with 453C.....
17843	3711	" " Lifting Lever.....
17844	3711	" " " " " Bracket for 63990.....
17845	3716	Presser Bar Lifting Lever Rod.....
17846	-----	" " " " " Chain.....
17848	20328	Pulley (loose) Bushing for 17955, obsolete
17853	7249	Starting Lever for 63754.....
17854	3721	Stop Cam for 17955 and 68720.....
17855	3721	" " Interlocking Rod for 39405.....
17859	20328	" " " " " Case Socket Joint for 63754.....
17861	3721	Stop Cam Interlocking Rod Case Stop Stud for 63754.....
17862	3721	Stop Cam Interlocking Rod Case Stop Stud Spring for 63754.....
17863	3721	Stop Cam Interlocking Rod Spring for 39405.....
17864	3721	Stop Cam Interlocking Rod Stop for 39405.
17865	3710	Thread Wiper Body.....
17866	3710	" " " Hook for 17708.....
17867	3710	" " " Support.....
17868	3710	" " " Wire.....
17869	3710	" " " " " Screw Washer.....
17872	3721	Trip Lever for 63754.....
17873	3721	" " Spring for 63754.....
17874	3717	Tripping Point for 68704 and 68707.....
17875	20326	Table Bracket Machine Holder with 2809, 7263, 39484 and two wood screws 1 1/4 in. No. 10 (Attachments and Accessor- ies).....
17876	3728	Treadle with 443C, for 17884.....
NOS. 17877 TO 17879 FOR 17880		
17877	3728	Treadle Pitman Rod (lower).....
17878	3728	" " " (upper).....
17879	3728	" " " Clamp with two 161E...
17880	3728	Treadle Pitman complete for 17885, Nos. 17877 to 17879.....
NOS. 17881 TO 17883 FOR 17884		
17881	3716	Treadle Shaft.....
17882	3718	" Spring.....
17883	3728	" Stand.....
17884	-----	Treadle complete for 17885, Nos. 17876, 17881 to 17883 and two wood screws 1 in. No. 10.....

No.	Plate	Name
17885	-----	Treadle and Pitman complete, for power table, Nos. 17880 and 17884.....
17886	3716	Starting Lever Pitman.....
17892	3728	Table Belt Guide Bracket with two 153E, for 39221.....
17893	3728	Table Belt Guide Pulley for 39221.....
17896	3718	" " " Shaft Plug for 39219 and 39220.....
17905	20338	Wrench for 1178,1654,1655,1676 and 1681 (Attachments and Accessories).....
17915	20329	Knife Bar Connection Slide Block for 63809.....
17919	20327	Knife Bar Driving Lever Lock Stud Spring for 39297.....
17927	7248	Clamp Arm with 17714 and 63788, for 68703
17928	20336	" Position Stud for 64000.....
17942	7249	Pulley (tight) 2 7/8 in. diam., with 2266 for 17955, obsolete.....
17955	-----	Pulleys complete, Nos. 1202R,1206C,17848, 17854,17942 and 63975,obsolete use 68717.....
18368	7247	Feed Plate Carrier Bar Plate for 39260...
18384	3753	" Cam Driving Worm Wheel Pin.....
18384	3753	" " Pin.....
18389	20329	Knife (needle thread) for 63844,obsolete, use 68708.....
18392	7211	Thread Take-up Cam 55302 with 446C.....
18393	7249	" " Lever with 1822, for 55283
18443	3754	Stop Cam Interlocking Rod Case Wearing Block for 63978.....
18471	3776	Knife Cam Lever Hinge Screw Bushing for 18472.....
18472	-----	Knife Cam Lever Hinge Screw Bushing 18471 with 50029C.....
18498	20326	Belt Cover.....
19793	20331	Knife Bar Stop Block Dowel Pin.....
19793	20331	" Cam Lever Slide Steady Pin for 39329.....
21829	3718	Needle Bar Connecting Stud with 155C, for 63756.....
22003	20338	Wrench for 1651 (Attachments and Accessories).....
24412	7214	Shuttle Bobbin Case Position Plate for 63842.....
26026	20338	Screw Driver (medium) Attachments and Accessories).....
26485	20338	Screw Driver (small) Attachments and Accessories.....

No.	Plate	Name
27321	3781	Bobbin Winder Frame for 41604.....
27325	8579	" " Stop Latch for 41604.....
27538	8579	" " Spindle 27849 with 15072, 27850 and 41328, for 41604.....
27662	20338	Wrench for 1254 and 1508 (Attachments and Accessories).....
27683	7242	Starting Lever Rock Shaft Arm with two 356C, for 63981.....
27739	20337	Thread Unwinder Thread Cone (wood) for large cones, for 225258.....
*27849	-----	Bobbin Winder Spindle for 27538.....
*27850	-----	" " " Collar for 27538...
27916	3781	" " Brake (leather) for 41598..
28034	3781	" " Rivet for 41598.....
32134	20336	Starting Lever Rock Shaft Spring for 63981.....
32675	20336	Presser Bar Spring.....
*33941	-----	Shuttle Bobbin Case for 33942.....
33942	7235	Shuttle Bobbin Case complete,for 63535, Nos. 591F,592E,2523,2975,7553,15141, 15278 and 33941.....
37310	20336	Feed Regulator Roller and Screw Stud Nut Washer for 1953.....
*39203	3718	Needle Bar Connecting Link for 63756.....
39218	3728	Table Belt Guide with two 168E, for 39221
39219	3728	" " Pulley Shaft (long) with 17896 and 63973, for 39221.....
39220	3728	Table Belt Guide Pulley Shaft (short) with 17896 and 63974, for 39221.....
39221	-----	Table Belt Guide complete, Nos. 17992, 39219,39220, two each 17993,39218 and three wood screws 1 1/4 in. No. 12...
39222	3774	Belt Shifter for 39405.....
39232	3749	Bed Frame Side Cover for 39233.....
39233	3749	" " with 39232, two each 9261,39325 39483 and four wood screws 1 1/4 in. No. 12.....
39234	3750	Drip Pan.....
39235	7248	Knife Cam Lever Body for 39409.....
*39259	3716	Feed Plate Carrier Bar for 39260.....
39260	-----	" " 39259 with 934J, 1195E,8505,17743,17902,17804,18368, two 7476 and four 17306.....
39262	3776	Knife Bar Cap (intermediate) for 39263...
39263	-----	" " 39262 with 1328E,1517J,39264 and 39265.....
39264	3776	Knife Bar Cap (intermediate) Stop Pin for 39263.....

No.	Plate	Name
39265	3776	Knife Bar Cap (intermediate) Stop Pin Spring for 39263.....
39269	20329	Knife Holder 68710 with 1338C, 17826, 17830 and two 7298, for 63844.....
39270	20328	Knife Holder Pinion Stud Bracket with 17827, for 63845.....
39276	3776	Needle Bar Thread Nipper Lever Spring....
39277	20329	Knife Thread Retainer Finger for 39291....
39278	20331	" " " Rivet for 39291.....
39290	3774	Belt Cover Bracket with 184E and 17741...
39291	20329	Knife Thread Retainer with 39277 and two 39278, for 63845.....
39297	3753	Knife Bar Driving Lever with 190J, 1420E, 17919 and 39298.....
39298	3753	Knife Bar Driving Lever Lock Stud for 39297.....
39299	3774	Knife Bar 63807 with 704C and 39300.....
39300	3776	" " Stop Block for 39299.....
39325	3776	Bed Frame Hinge Connection for 39233.....
39329	-----	Knife Cam Lever complete, Nos. 19793 and 39409.....
39330	3776	Knife Cam Lever Slide with 1980, for 39460.....
39331	3776	Knife Cam Lever Slide Screw Washer for 39460.....
39332	3774	Knife Cam Lever Bracket with 1177J.....
39343	3774	Stop Cam Interlocking Rod Case Spring (flat) for 39347.....
39344	3776	Stop Cam Interlocking Rod Case Spring Bracket with 1520J and 50682C, for 39347.....
39346	7249	Stop Cam Interlocking Rod Case Bracket for 63754.....
39347	-----	Stop Cam Interlocking Rod Case Bracket 63754 with 39343, 39344 and two 1186J.
39350	7249	Needle Bar Thread Nipper Driving Lever (adjustable) with 39351 and two 335J.
39351	3776	Needle Bar Thread Nipper Driving Lever Extension for 39350.....
39352	7249	Needle Bar Thread Nipper Driving Lever Spring.....
*39405	-----	Stop Cam Interlocking Rod Case 63993 with 1318D, 17855, 17863, 17864 and 39222, for 63754.....
39409	-----	Knife Cam Lever Body 39235 with 39460, for 39329.....
39460	-----	Knife Cam Lever Slide 39330 with 1255J and 39331, for 39409.....

No.	Plate	Name
39483	7214	Bed Frame Cushion (leather) for 39233....
39484	3718	Table Bracket Machine Holder Cushion (leather) for 17875.....
39486	7214	Throat Plate Needle Hole Bushing for 63786.....
39489	7008	Protector Arm with 39490, for 63753.....
39490	-----	" Blade for 39489.....
NOS. 39491 TO 39494 FOR 63753		
39491	7008	Protector Bracket with two each 426C and 448C.....
39492	7009	Protector Crank with 160C.....
39493	7009	" " Bracket with 1120C and two 454C.....
39494	7008	Protector Rod.....
39495	7009	" " Connection for 39498.....
39496	7008	" " Sleeve for 63753.....
39497	7009	" " Spring for 63753.....
39498	-----	Protector (front of needle) complete, Nos. 39495, 63753 and two each 176J and 50351J.....
41401	7231	Machine Rest Pin (wood) 5 11/16 in. long (Attachments and Accessories).....
41598	8579	Bobbin Winder Bar with 27916 and two 28084, for 41604.....
41600	8579	Bobbin Winder Pulley with 155C, for 41604
41604	8579	" " for 41716, Nos. 35D, 1820J, 27321, 27328, 27535, 41598, 41600, 41825 and 50356D.....
41716	-----	Bobbin Winder (swinging automatic, left hand) complete, for 2996, Nos. 181J, 41604, 60770 and two 1186C.....
41825	3781	Bobbin Winder Frame Spring for 41604.....
41828	-----	" " Spindle Collar Pin for 27538
43808	3781	" " Tension Spring for 60770...
46244	7235	Feed Across Regulator Adjusting Screw Stud Nut Washer (fibre).....
50018F	3778	Knife Holder Pinion Stud Bracket Screw for 63845.....
50029C	3776	Knife Cam Lever Hinge Screw for 18472....
50333C	20331	Arm Shaft Bushing (back) Adjusting Screw.
50351J	7009	Protector Bracket Screw for 39498.....
50356D	3781	Bobbin Winder Frame Hinge Screw for 41604
50406J	20331	Throat Plate Extension Screw for 63786...
50599D	7235	Feed Across Regulator Adjusting Screw Stud.....
50682C	7235	Stop Cam Interlocking Rod Case Spring Adjusting Screw for 39344.....

No.	Plate	Name
51387R	20336	Pulley (loose) Cap Screw for 68717.....
52598	7009	Protector Crank Hinge Stud for 63753.....
55283	-----	Thread Take-up Lever 18393 with 79F.....
*55302	-----	" " Cam for 18392 and 55440...
55381	7235	Feed Across Connection (lever end) Ball Stud for 63941.....
*55440	-----	Arm Shaft 17702 with 55302 and 68717.....
*56787	-----	Oscillating Shaft 3168 with 2049,2542 and 15164.....
56791	-----	Tension complete for 17725, Nos. 2103, 2124,16202 and two 2102.....
56864	7231	Chain Hook (large) for 6439.....
56864	7231	Starting Lever Rock Shaft Chain Hook for 14224.....
56865	7235	Chain Hook (small) for 6439.....
60789	8579	Bobbin Winder Tension Bracket for 60770..
60770	8579	Bobbin Winder Tension Bracket complete for 41716, Nos. 419E,1562J,8422,9780, 43808,60769 and two 2455.....
62155	7246	Feed Cam Shaft for 124927.....
63535	20329	Shuttle, 1 11/16 in. diam., Nos. 2515, 2996 and 33942.....
*63736	-----	Face Plate 17724 with 2105, for 17725....
63753	-----	Protector (front of needle) for 39498, Nos. 1099F,39489,39491 to 39494,3949E 39497,52598 and two 15261.....
63754	-----	Stop Cam Interlocking Rod Case Bracket complete for 39347, Nos. 1182E,1196C, 1204E,1254C,1262C,1508J,1662C,17853, 17859,17861,17862,17872,17873,39346, 39405 and two 898J.....
63756	-----	Needle Bar Connecting Link 39203 with 21629.....
63786	20330	Throat Plate 63997 with 17749,39486 and two each 1208D and 50406J, for 63845.
63788	20327	Clamp Arm Hook for 17927.....
*63806	-----	Knife Bar for 63807.....
63807	-----	" " 63806 with 63808,63809 and two 17814, for 39299.....
63808	20328	Knife Bar Connection for 63807.....
63809	-----	" " Slide Block 17915 with 63810, for 63807.....
63810	20329	Knife Bar Connection Slide Block Stud for 63809.....
63840	-----	Shuttle Race Body for 63946.....
63941	20329	" " Cap for 63946.....
63842	7211	Shuttle Race complete, Nos. 907D,2531, 2533,24412,63946 and two each 391J and 2532.....

No.	Plate	Name
63844	-----	Knife Holder 39269 with 1198C,17808,17829 and 68708, for 63845.....
63845	-----	Throat Plate 63786 with 1696C,39270,39291 50018F and 63844.....
63940	7235	Feed Across Connection (lever end) with two 896E, for 63941.....
63941	-----	Feed Across Connection (lever end) 63940 with 55381.....
63942	7235	Feed Across Connection (regulator end) with two 896E, for 63943.....
63943	-----	Feed Across Connection (regulator end) 63942 with 63944.....
63944	7235	Feed Across Connection (regulator end) Ball Stud for 63943.....
63946	-----	Shuttle Race Body 63840 with 1053J,2523 and 63841, for 63842.....
63973	7246	Table Belt Guide Pulley Shaft (long) Wick (braided cotton) for 39219.....
63974	7246	Table Belt Guide Pulley Shaft (short) Wick (braided cotton) for 39220.....
63975	7246	Pulley (loose) 2 3/4 in. diam., for 17955 obsolete.....
63976	7235	Belt Shifter Clamp for 63993.....
63977	7246	Stop Cam Interlocking Rod Case for 63978.
63978	-----	" " " " 63977 with 18443 and two 193J, for 63993.....
63981	-----	Starting Lever Rock Shaft complete for stand No. 25297, Nos. 7124,14224, 32134 and two each 2770,18128 and 27683.....
*63990	-----	Arm with 4449,15404,17844 and two each 164E and 15405.....
63993	-----	Stop Cam Interlocking Rod Case 63978 with 63976 and two 1255J, for 39405.....
63997	20330	Throat Plate Body for 63786.....
64000	7247	Clamp Foot with 1220F,17928,68701,68702 and two 337J, for 68703.....
68701	7247	Clamp Foot Belt Loop Guide (back) for 64000.....
68702	7247	Clamp Foot Belt Loop Guide (front) for 64000.....
68703	-----	Clamp complete, Nos. 1656J,17927 and 64000.....
68704	7247	Feed Cam with 17874 and two each 190J and 1192C (double nipper depression)....
68705	7247	Feed Plate with 240J and 68706.....
68706	7247	" " Belt Loop Stop for 68705.....
68707	7248	Feed Cam with 17874 and two each 190J and 1192C (single nipper depression)....

No.	Plate	Name
68708	20336	Knife (needle thread) for 63844.....
68710	20329	" Holder for 39269.....
68712	20337	Pulley (loose) 2 3/4 in. diam. with 200584D, for 68713.....
68713	-----	Pulley (loose) 68712 with 68714, for 68717.....
68714	20337	Pulley (loose) Ball Bearing, for 68713...
68715	20336	" " Bushing for 68717.....
68716	20337	" (tight) 2 7/8 in. diam., for 6872C
68717	-----	Pulleys (ball bearing) complete, for 55440, Nos. 51387R, 68713, 68715 and 68720.....
68720	-----	Pulley (tight) 68716 with 1206C and 17854 for 68717.....
120341	20338	Tweezers (curved) Attachments and Accessories.....
120346	20338	Oiler (copper plated) with 120347 (Attachments and Accessories).....
120347	20338	Oiler Spout, 9 in. long, for 120346.....
124674	20328	Arm Side Cover.....
124925	7248	Feed Cam Driving Worm with 1441C and 1442C.....
124926	7248	Feed Cam Driving Worm Wheel with 453C, for 124927.....
124927	-----	Feed Cam Shaft 62155 with 1653C and 124926.....
150203	20335	Thread Unwinder Spool Rest Cushion (felt) for 225258.....
200383C	7235	Thread Unwinder Spool Rest Rod Set Screw for 202490.....
200584D	20336	Pulley (loose) Oil Plug Screw for 68712..
201018C	7235	Thread Unwinder Spool Rest Set Screw for 225257.....
201696J	7235	Thread Unwinder Thread Guide Lock Nut for 225258.....
202490	20335	Thread Unwinder Spool Stand with 200383C, for 225258.....
225257	20335	Thread Unwinder Spool Rest (for two spools) with 201018C, for 225258.....
225258	20335	Thread Unwinder complete, for two spools, Nos. 201696J, 202490, 225257, 225324, 225326, 225388, two each 150203, 225391 and three wood screws 7/8 in. No. 12.
225322	20336	Thread Unwinder Thread Guide Rod Washer for 225324.....
225324	20335	Thread Unwinder Thread Guide Rod with 208E and 225322, for 225258.....
225326	20335	Thread Unwinder Thread Guide Position Cup for 225258.....

No.	Plate	Name
225388	20335	Thread Unwinder Spool Rest Rod for 225258.....
225390	20337	Thread Unwinder Thread Cone Holder for inverted cones, for 225258.....
225391	20335	Thread Unwinder Thread Guide for 225258..

Genuine Singer Needles should be used in Singer Machines. These Needles and their Containers are marked with the Company's Trade Mark "SIMANCO." 1

Needles in Containers marked "For Singer Machines" are not Singer made needles. 2

PLATE 3710—FULL SIZE

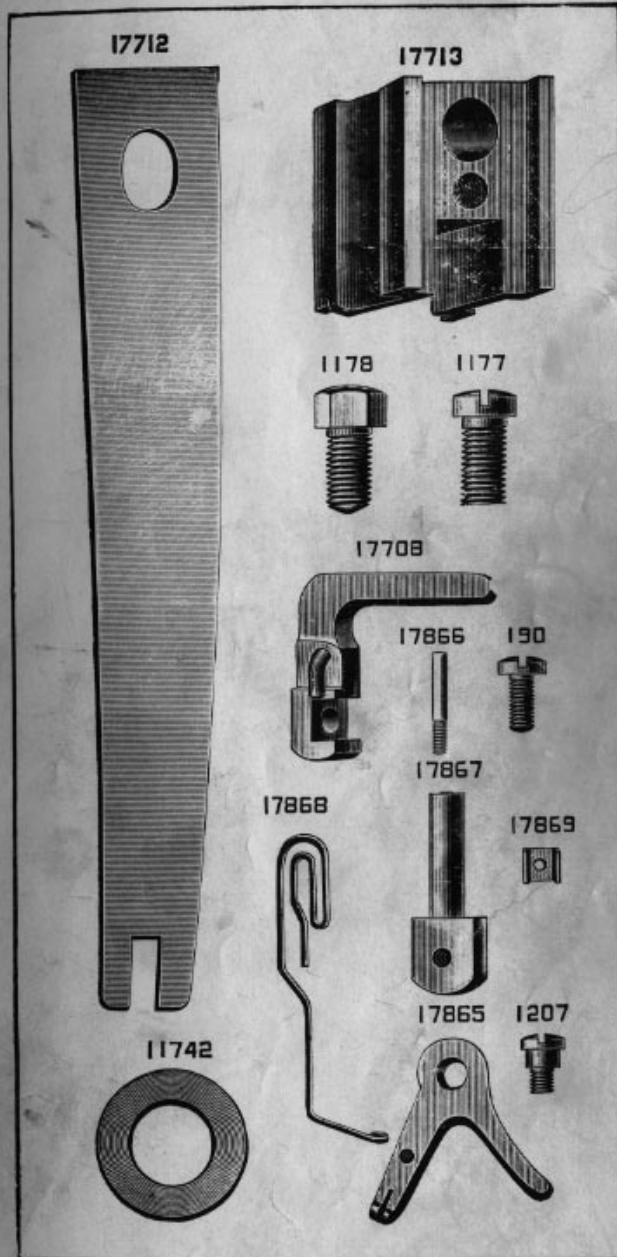

PLATE 3711—ONE-HALF SIZE

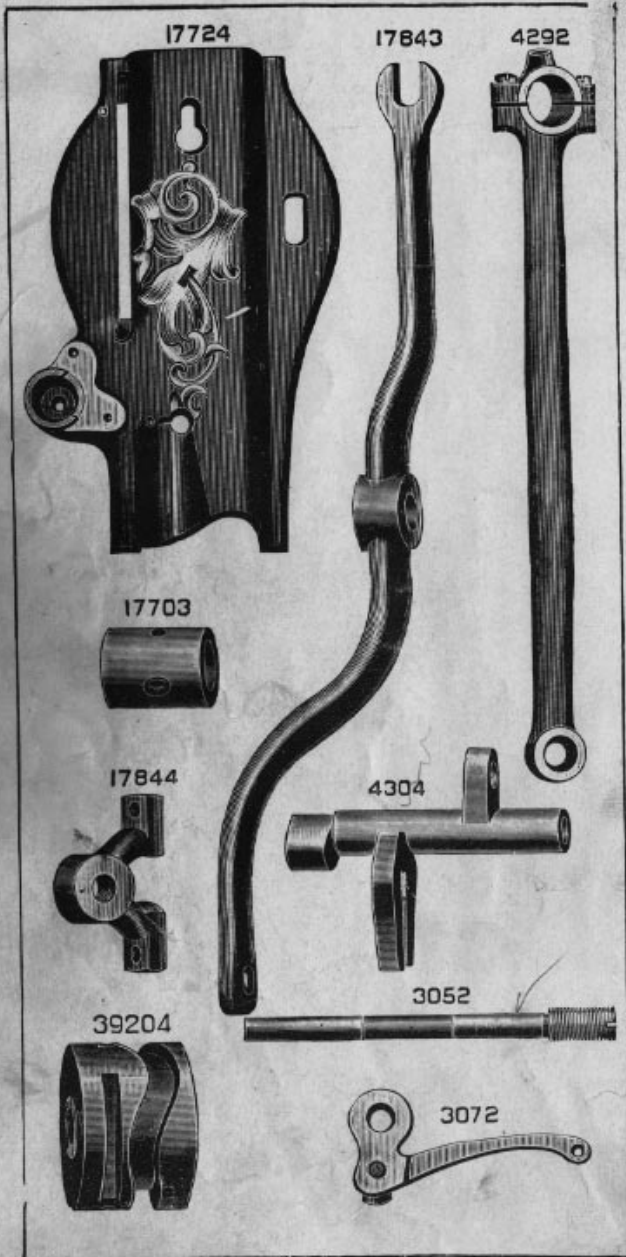

PLATE 3713—ONE-HALF SIZE

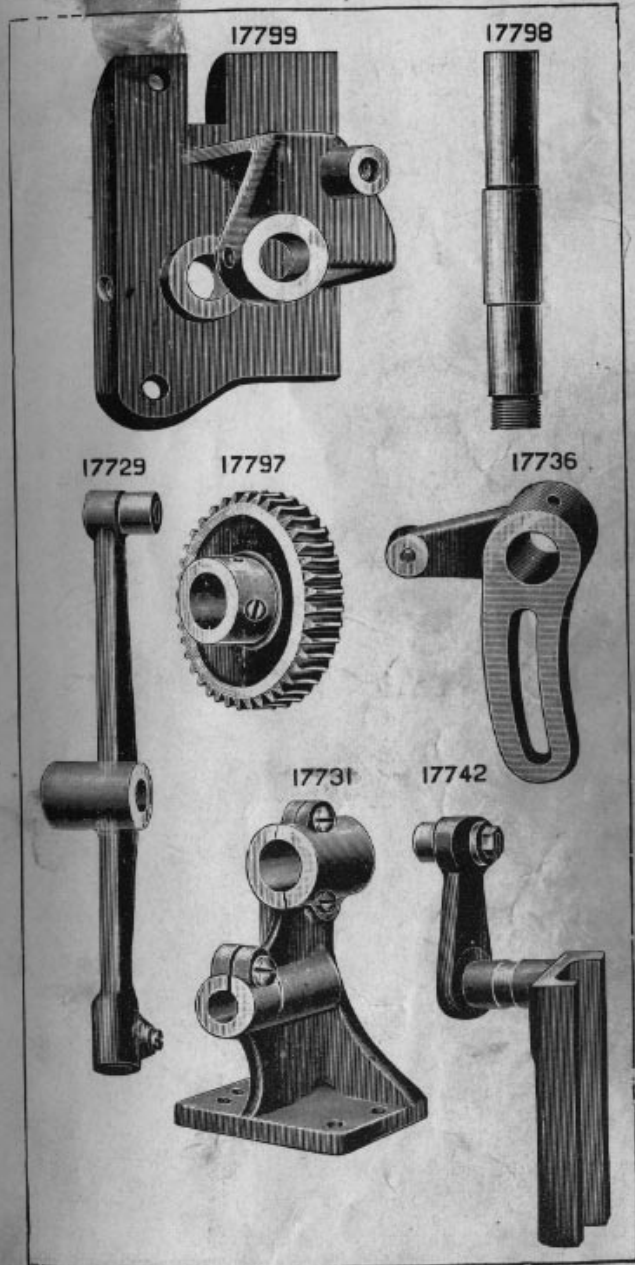

PLATE 3716—ONE-HALF SIZE

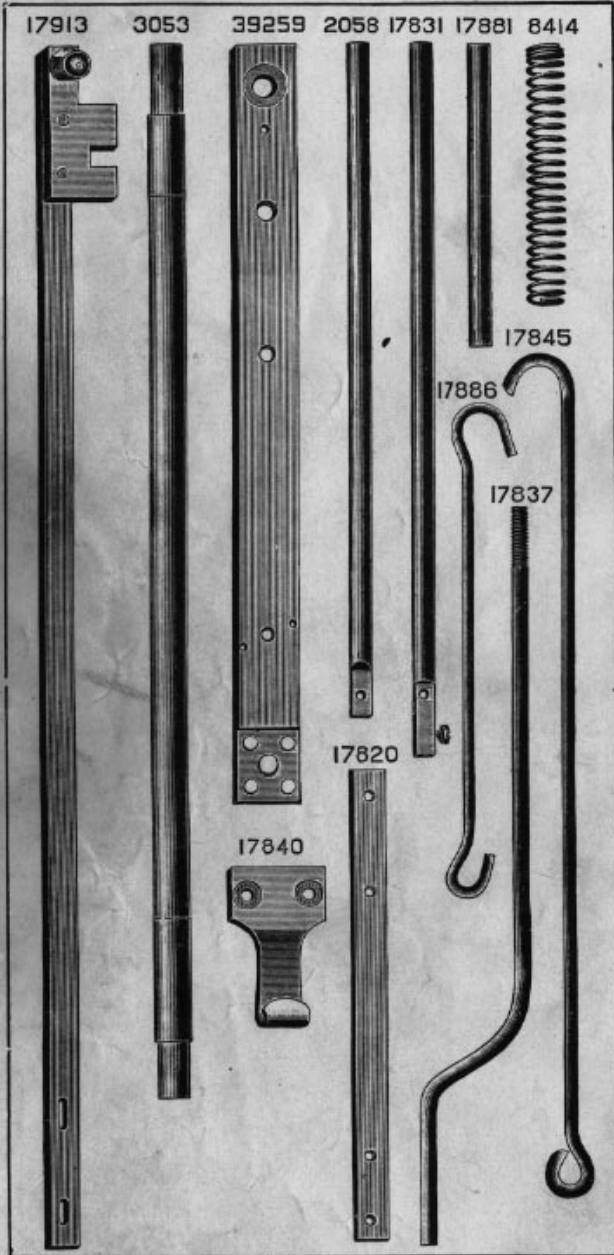

PLATE 3717—FULL SIZE

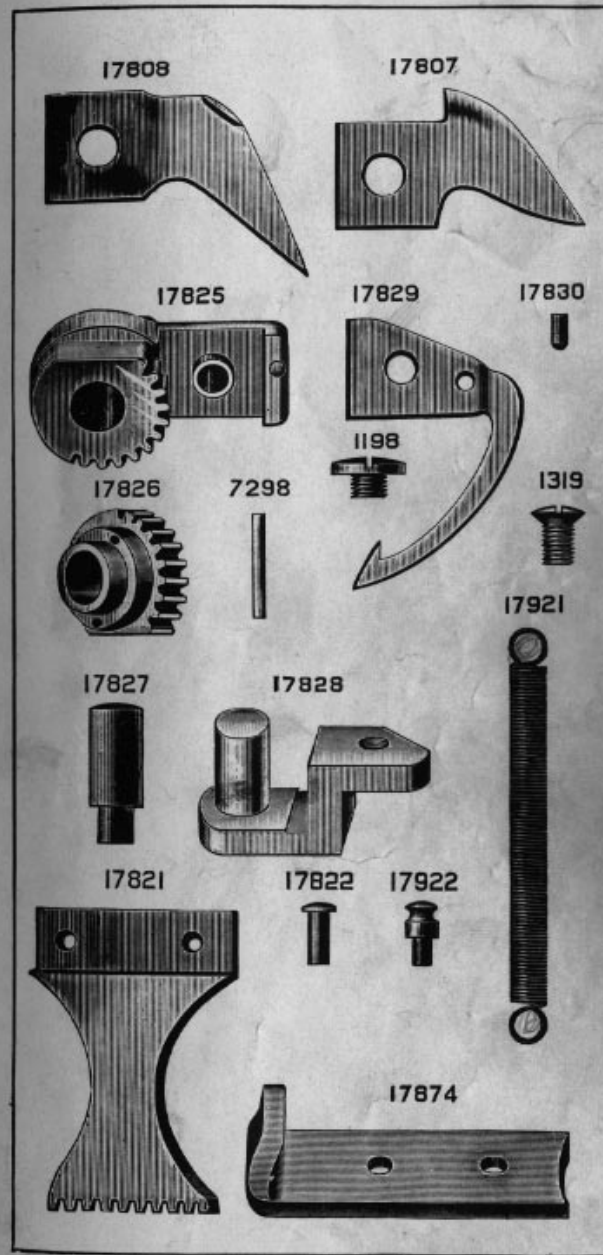

PLATE 3718—FULL SIZE

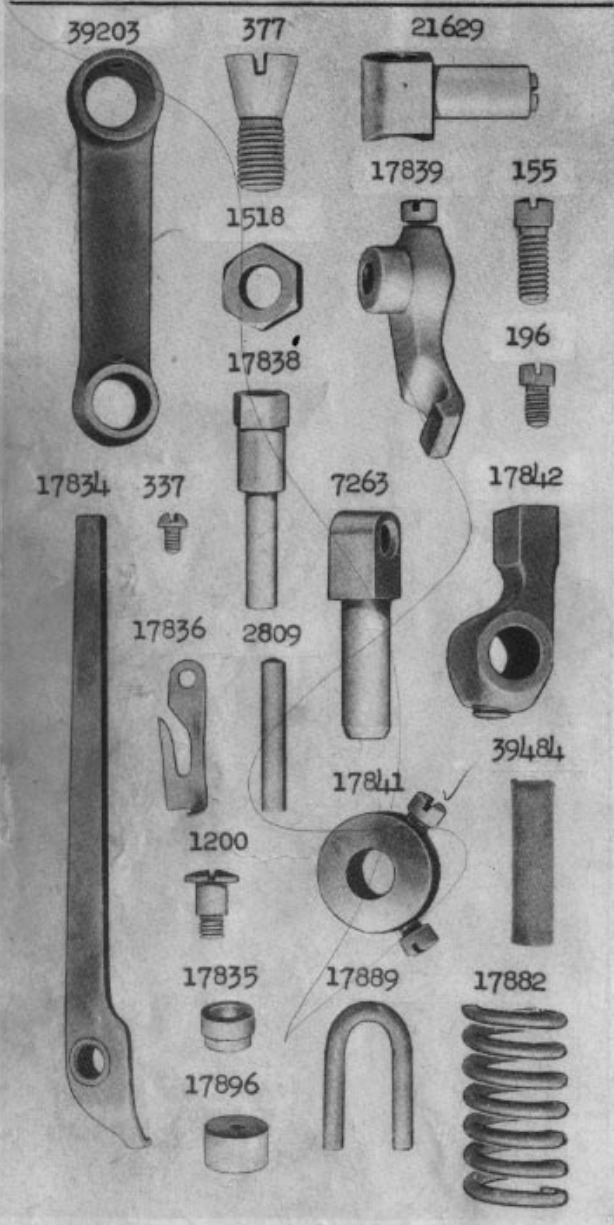

PLATE 3721—FULL SIZE

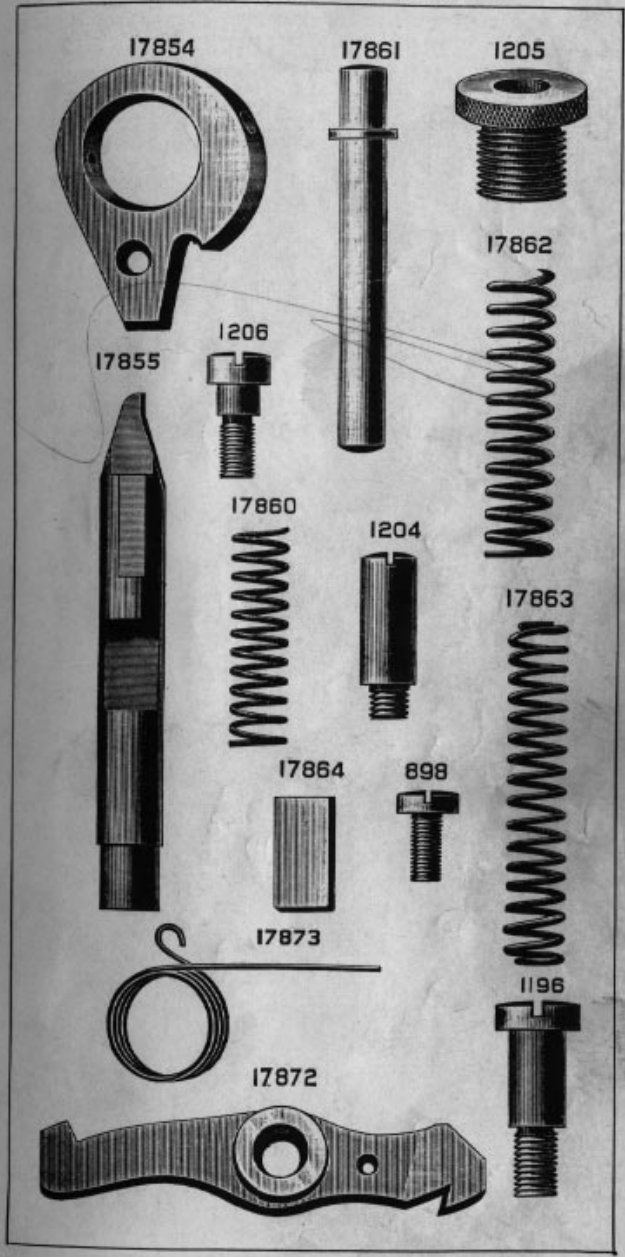

PLATE 3722—FULL SIZE

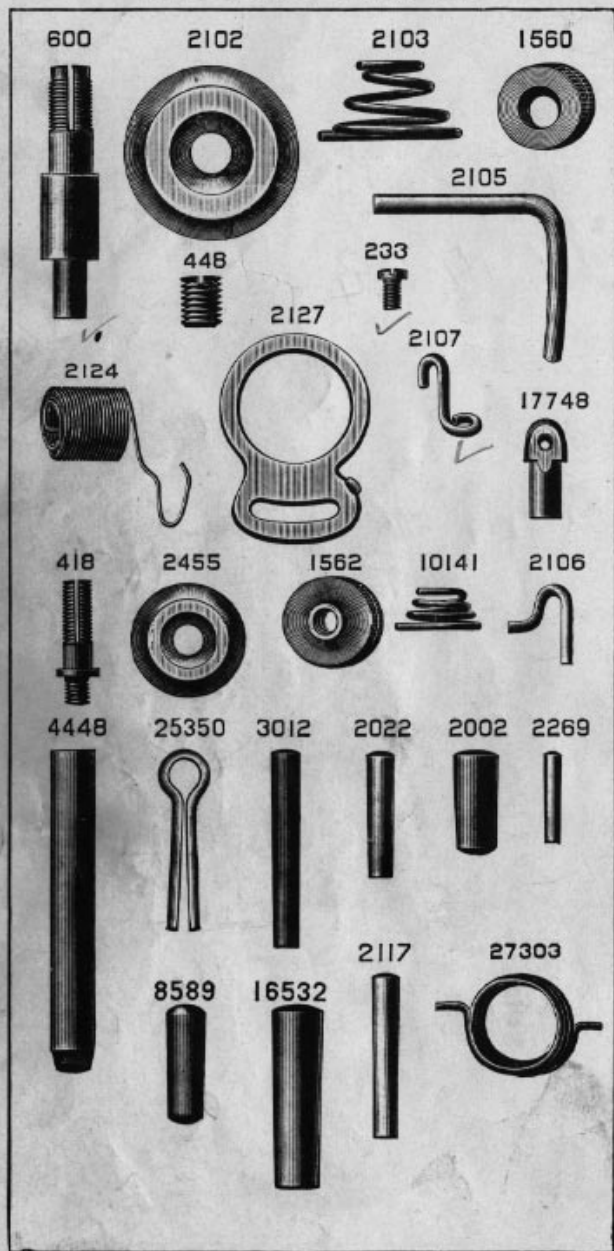
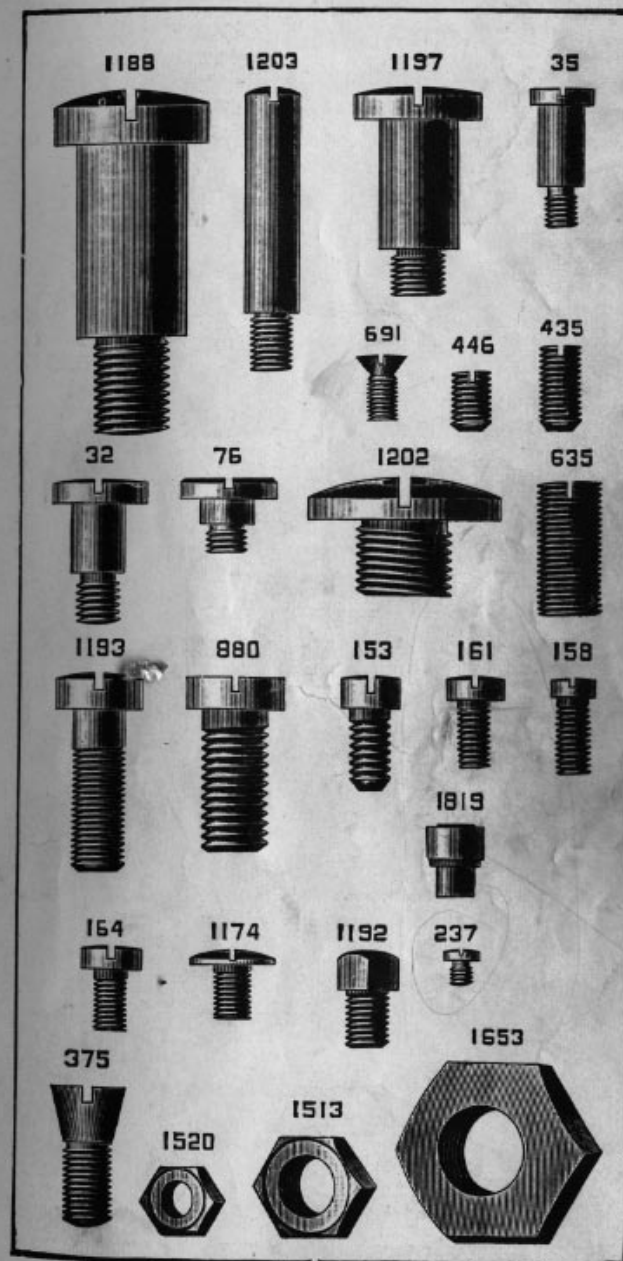

PLATE 3724—FULL SIZE



Ch
PLATE 3728—ONE-FOURTH SIZE

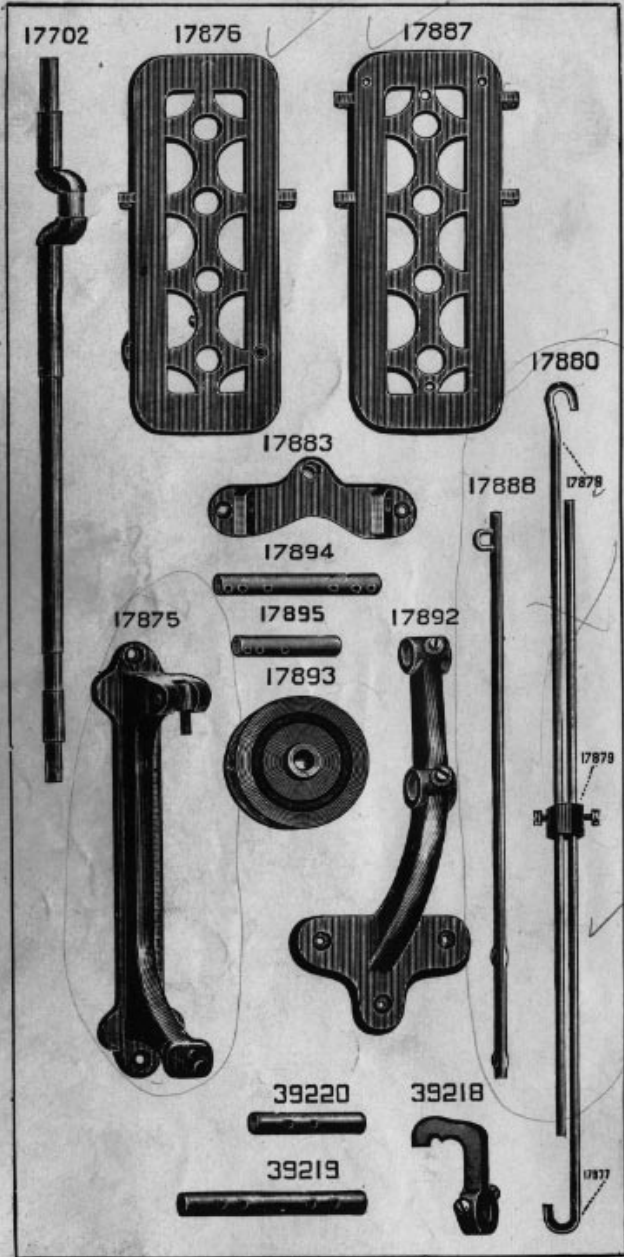

PLATE 3749—ONE-FOURTH SIZE

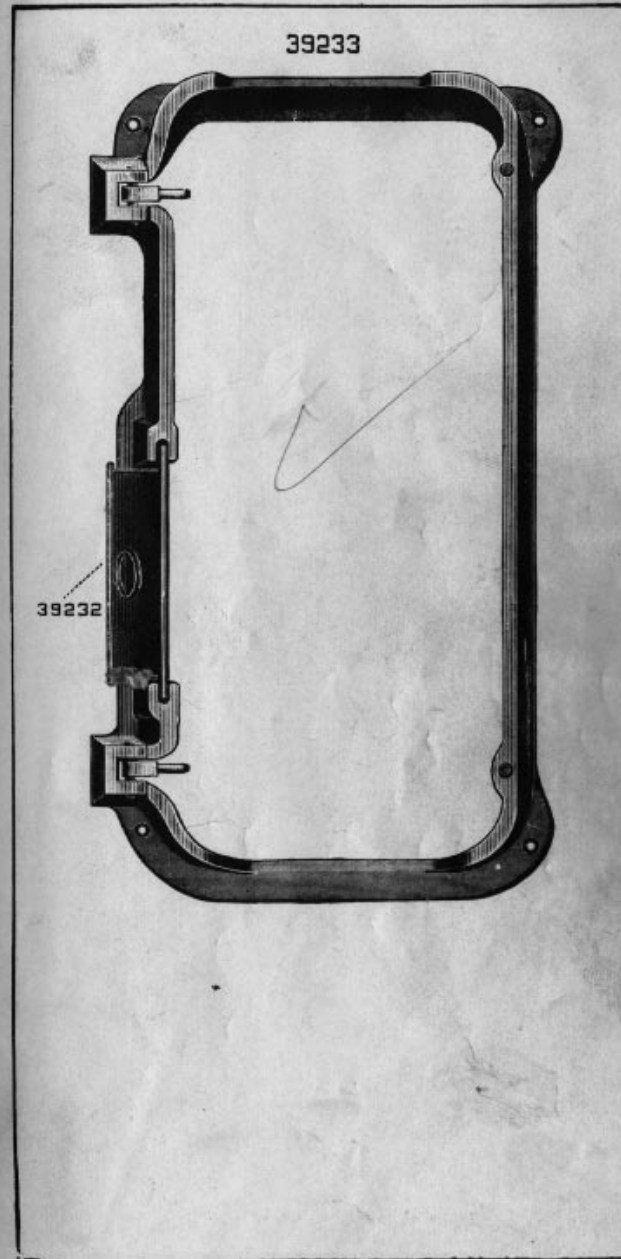

PLATE 3750—ONE-FOURTH SIZE

39234



PLATE 3753—FULL SIZE

39297

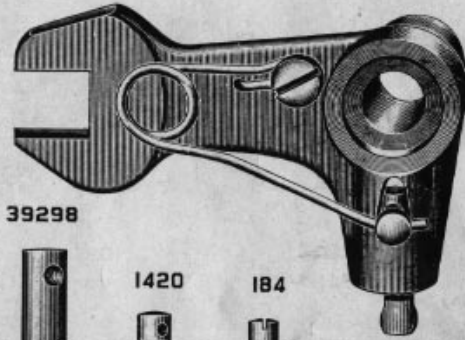

39298



1420



184



1382



1681



18384



1343



39272



186



207



456



208



79



50018



41515



41569



1698



1822



1149



PLATE 3754—FULL SIZE

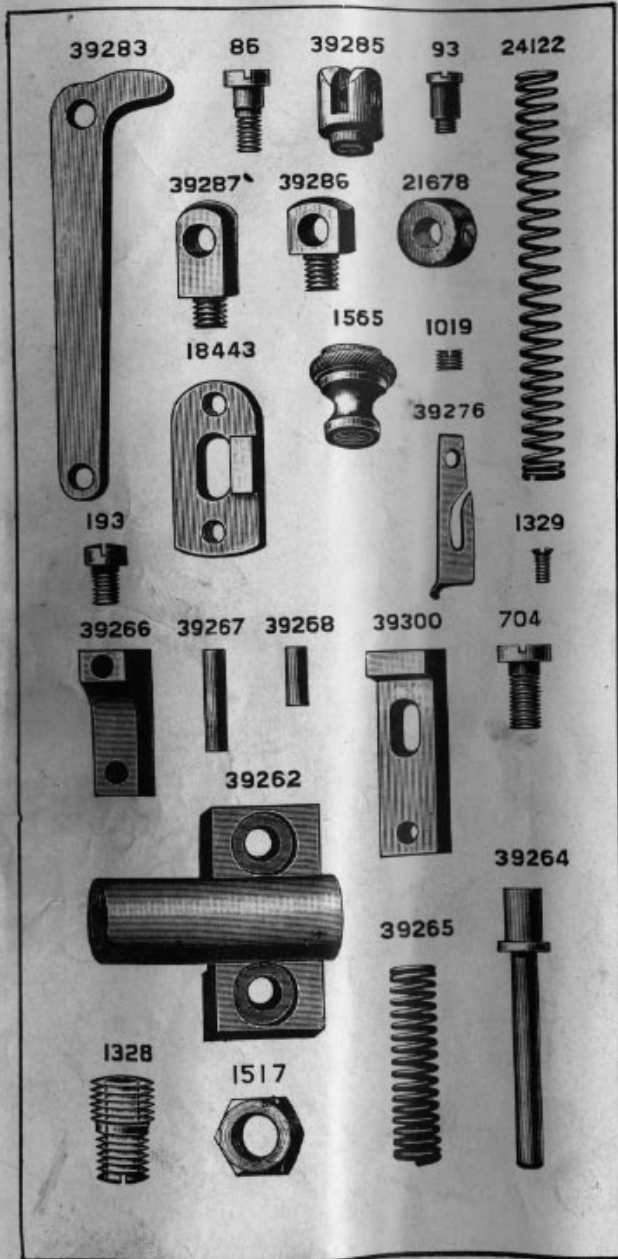

PLATE 3774—ONE-HALF SIZE

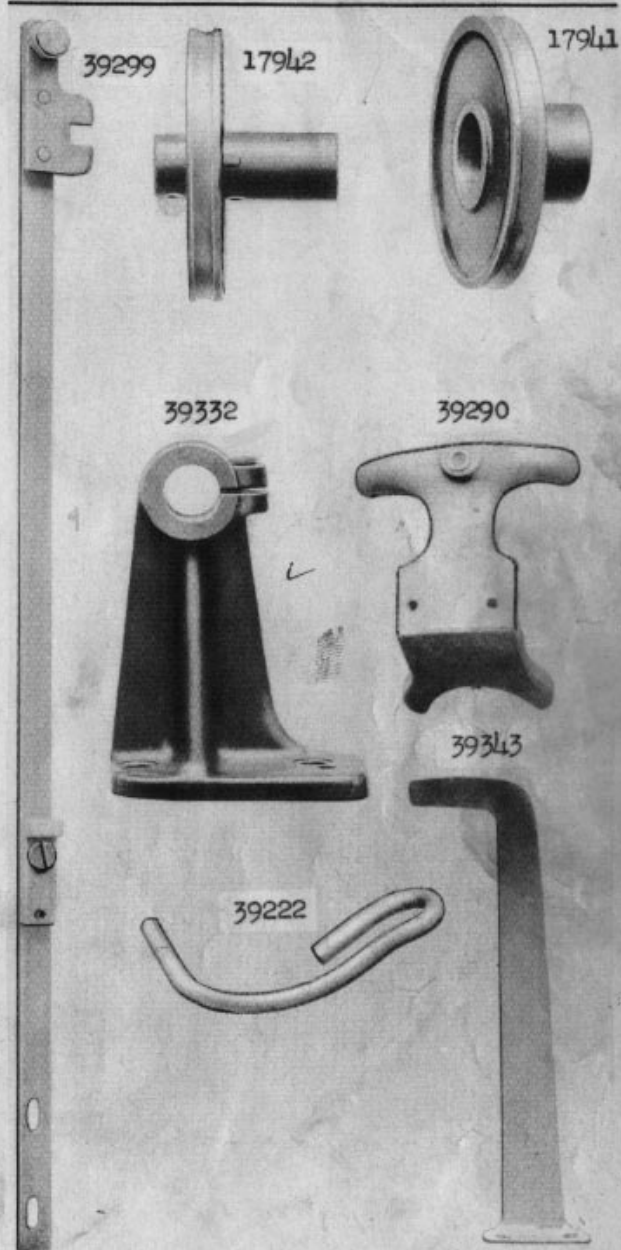

PLATE 3776—FULL SIZE

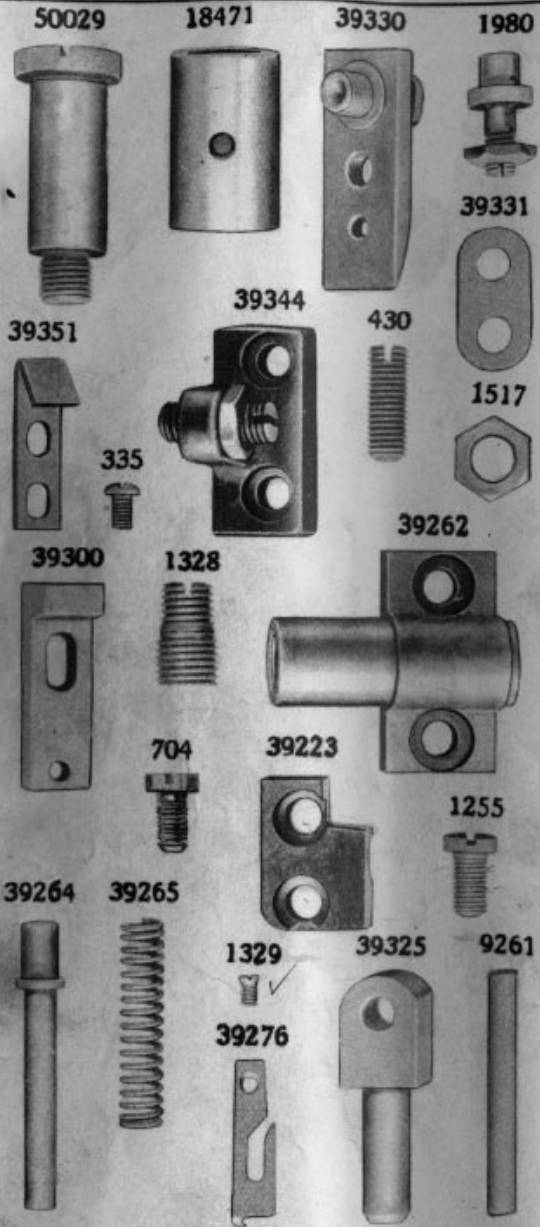

PLATE 3778—FULL SIZE

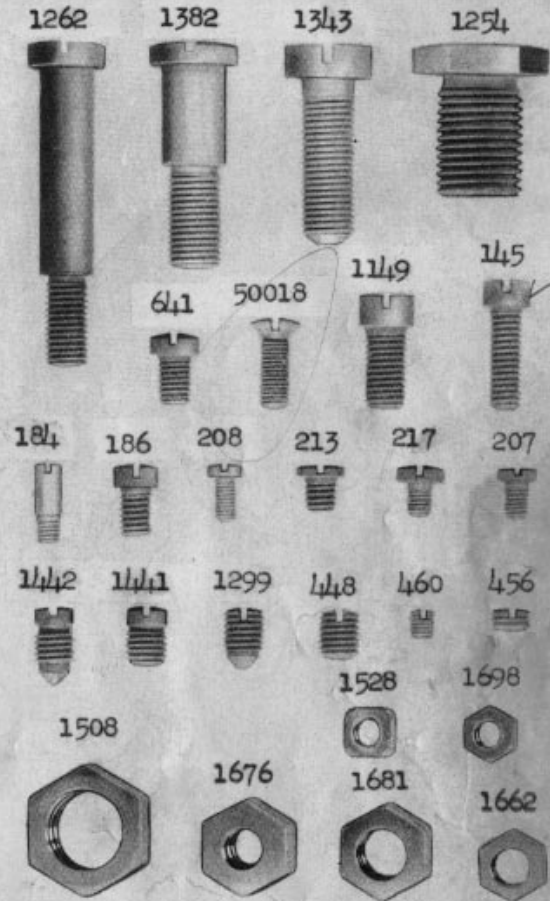

PLATE 3781—FULL SIZE

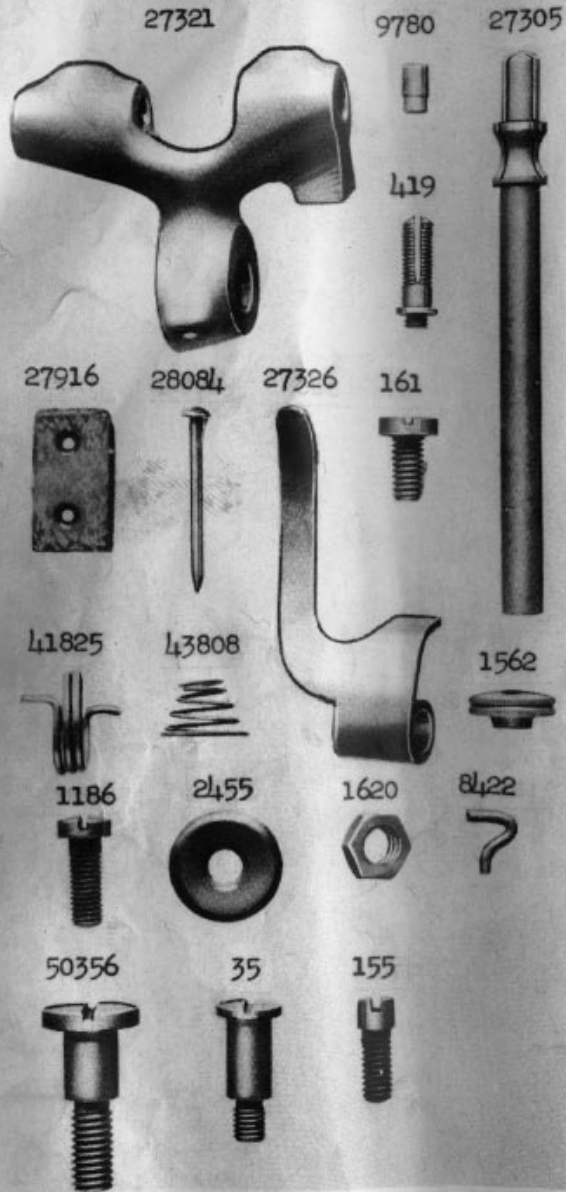

PLATE 7008—ONE-HALF SIZE

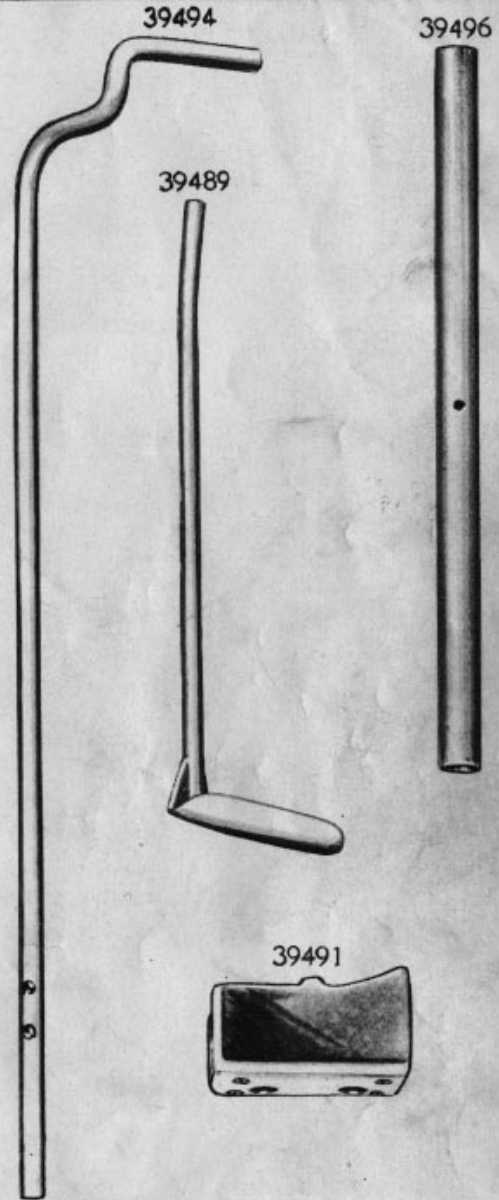

PLATE 7009--FULL SIZE

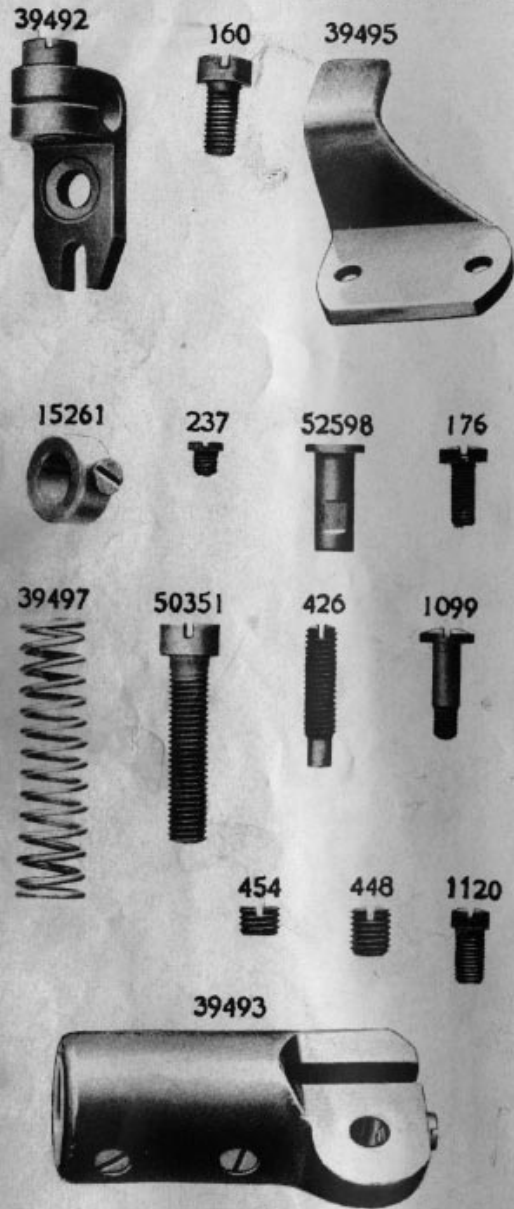
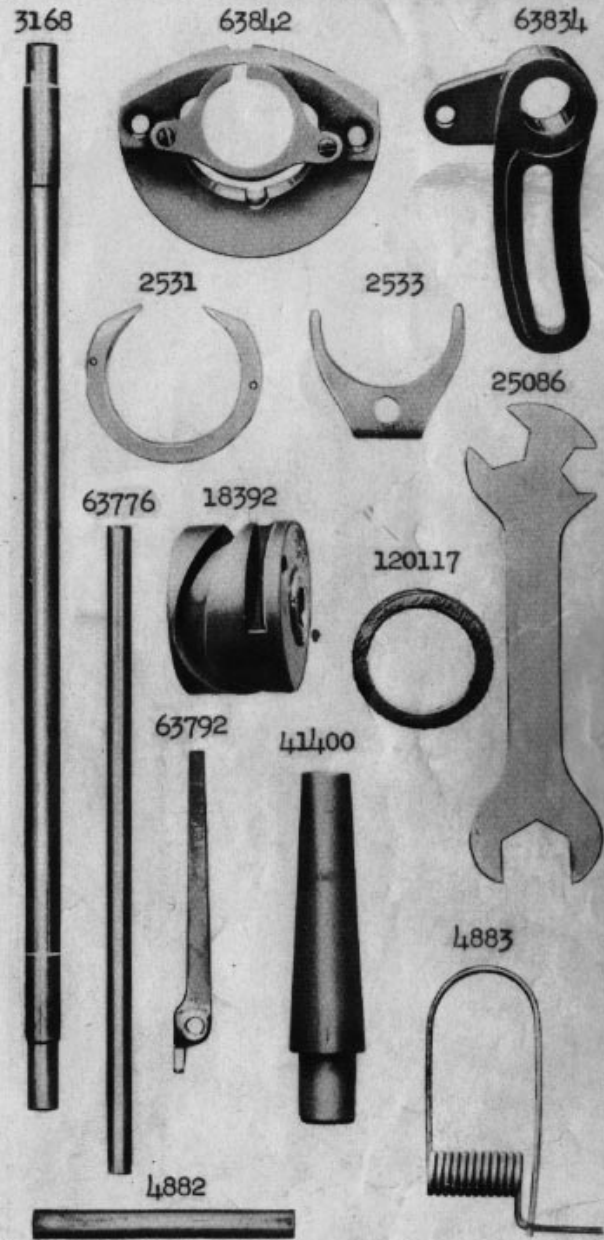

PLATE 7211--ONE-HALF SIZE



From the library of: Diamond Needle Corp

PLATE 7214—FULL SIZE



PLATE 7231—ONE-HALF SIZE

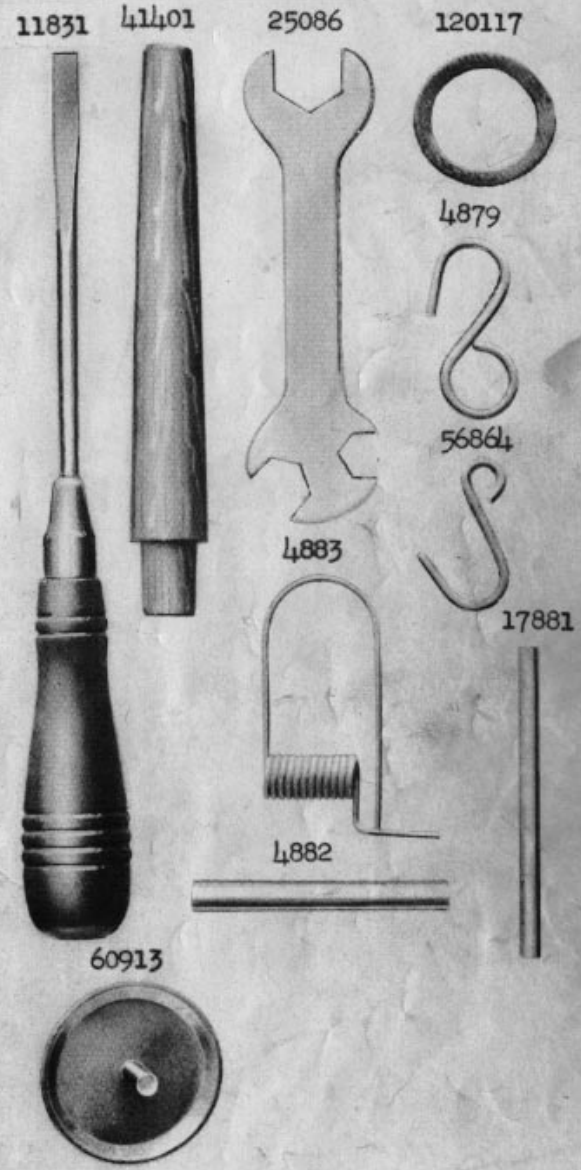

From the library of: Diamond Needle Corp

PLATE 7235—FULL SIZE

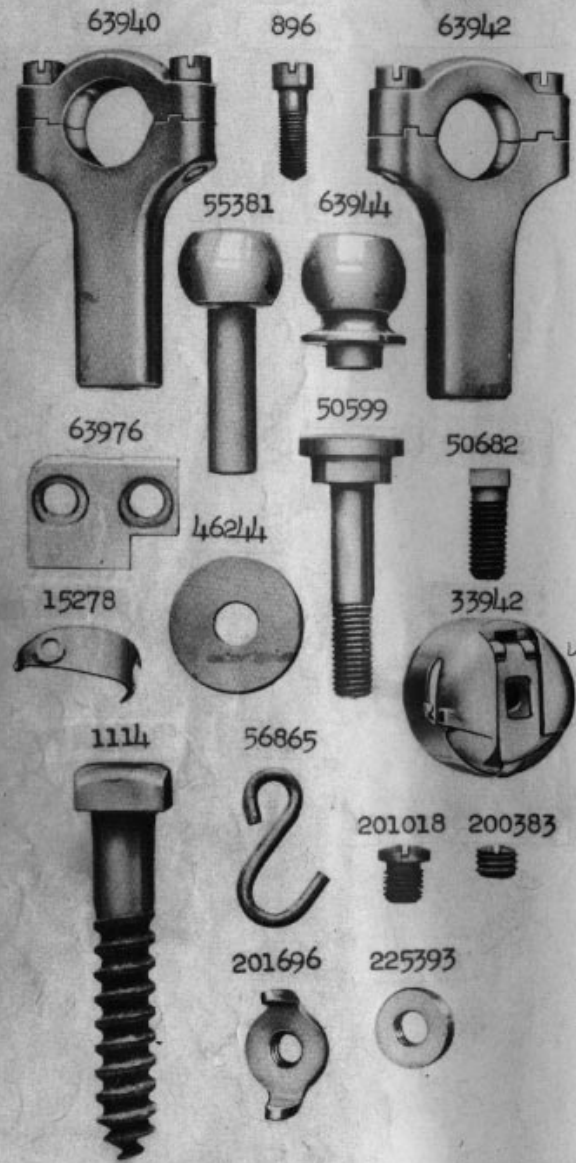

PLATE 7242—ONE-HALF SIZE

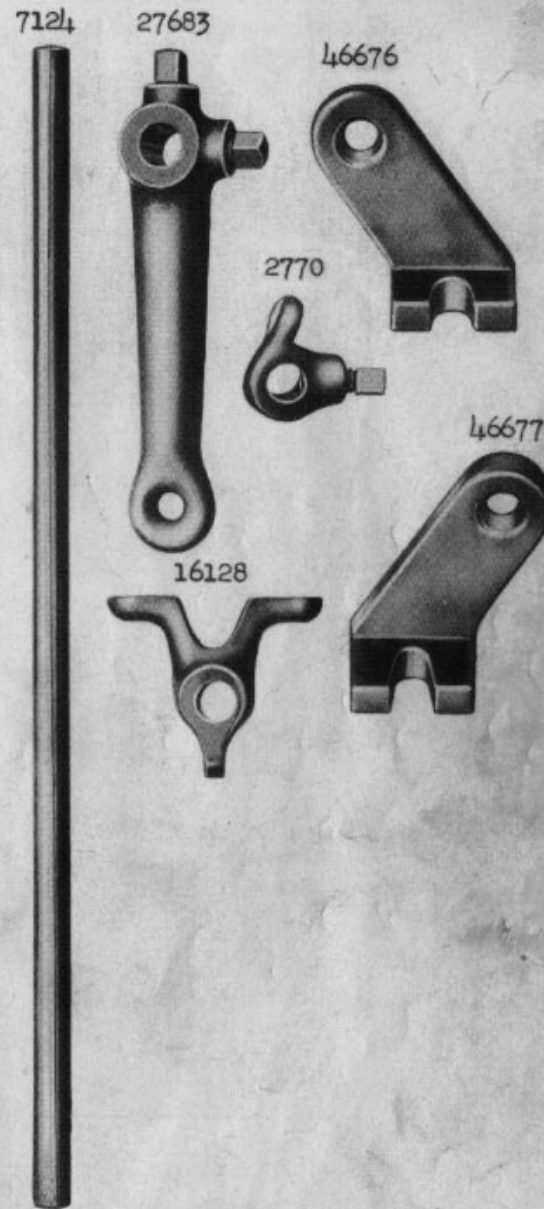

PLATE 7246—ONE-HALF SIZE

63977



62155



63973



63974



46713

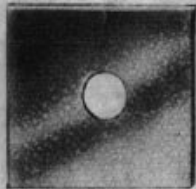

63975

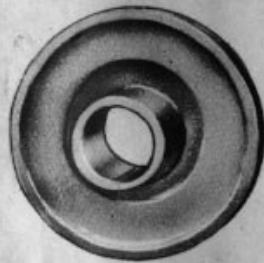
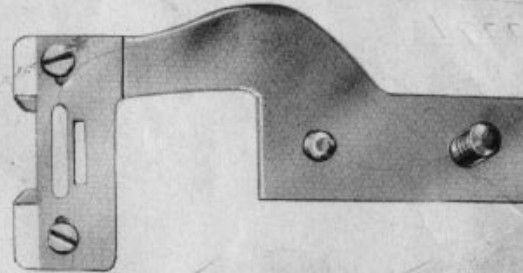
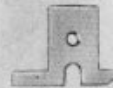

PLATE 7247—FULL SIZE

64000



68701



68702



240



68705

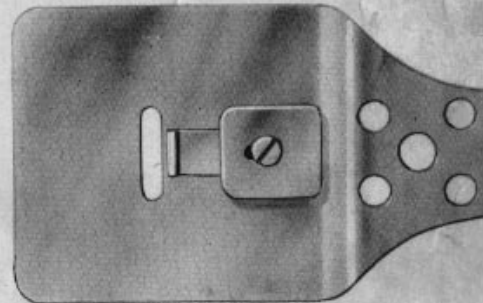

17802



68706



17803

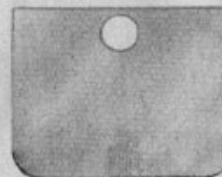

18368



From the library of: Diamond Needle Corp

PLATE 7248—ONE-HALF SIZE

68707 = SINGLE NIPPER DEPRESSION

68704 = DOUBLE NIPPER DEPRESSION

17791

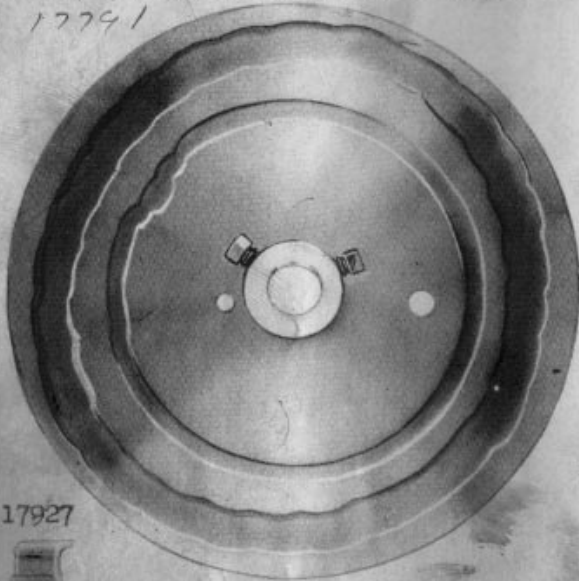

17927



39235



124926



124925

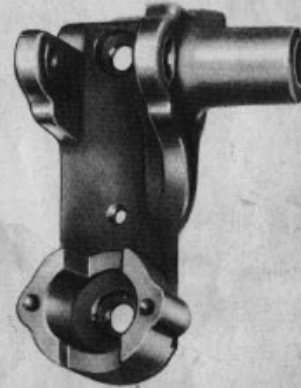

PLATE 7249—ONE-HALF SIZE

225324



39346



17942



39352



17853



39350



18393

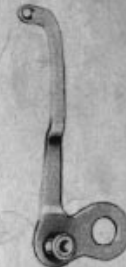

From the library of: Diamond Needle Corp

PLATE 8579—ONE-HALF SIZE

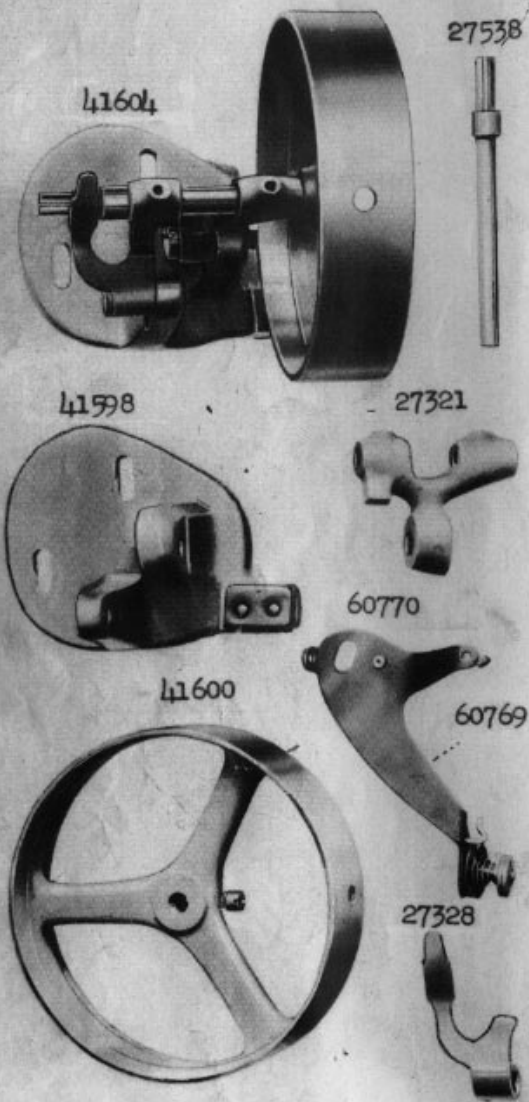

PLATE 20326—ONE-FOURTH SIZE

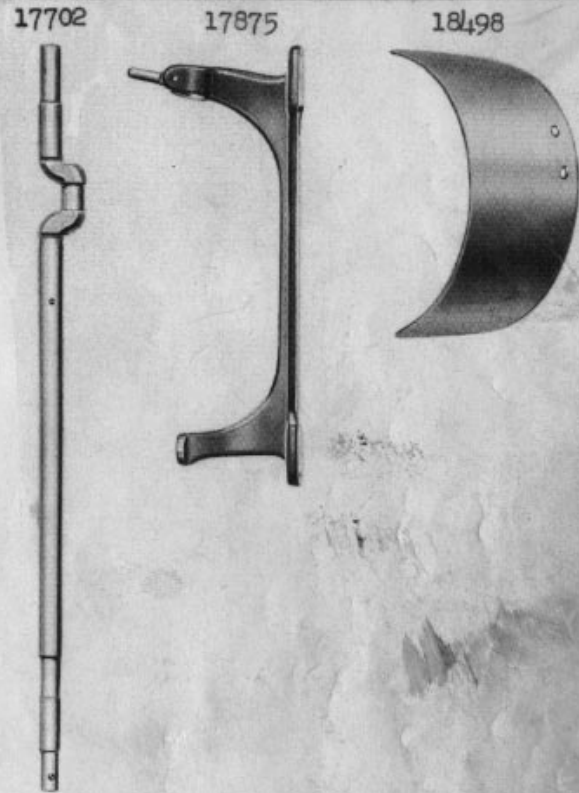
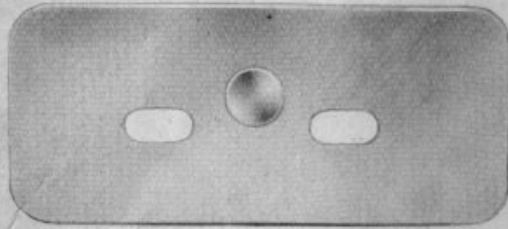
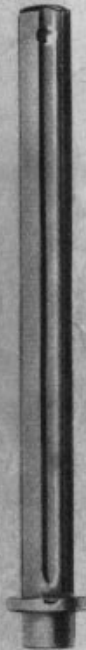

PLATE 20327—FULL SIZE

17735



17743



17726



17737



17744



17805



17745



63788



17919



17740

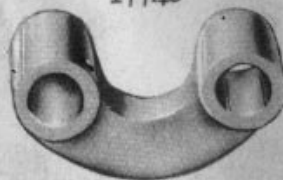
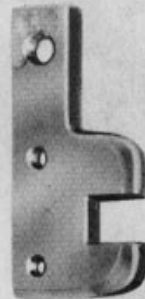
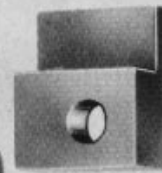

PLATE 20328—FULL SIZE

63808



17810



39270

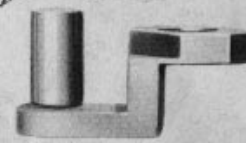

17811

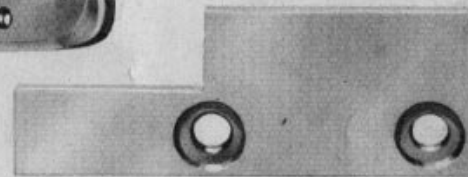

124674

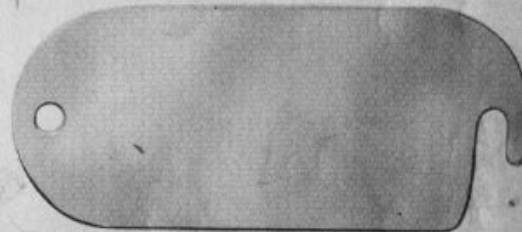

17859

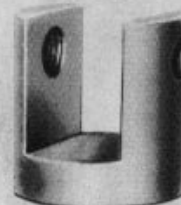

17710



17714



17738

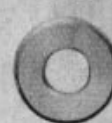

17848

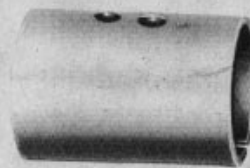

14017



From the library of: Diamond Needle Corp

PLATE 20329—FULL SIZE

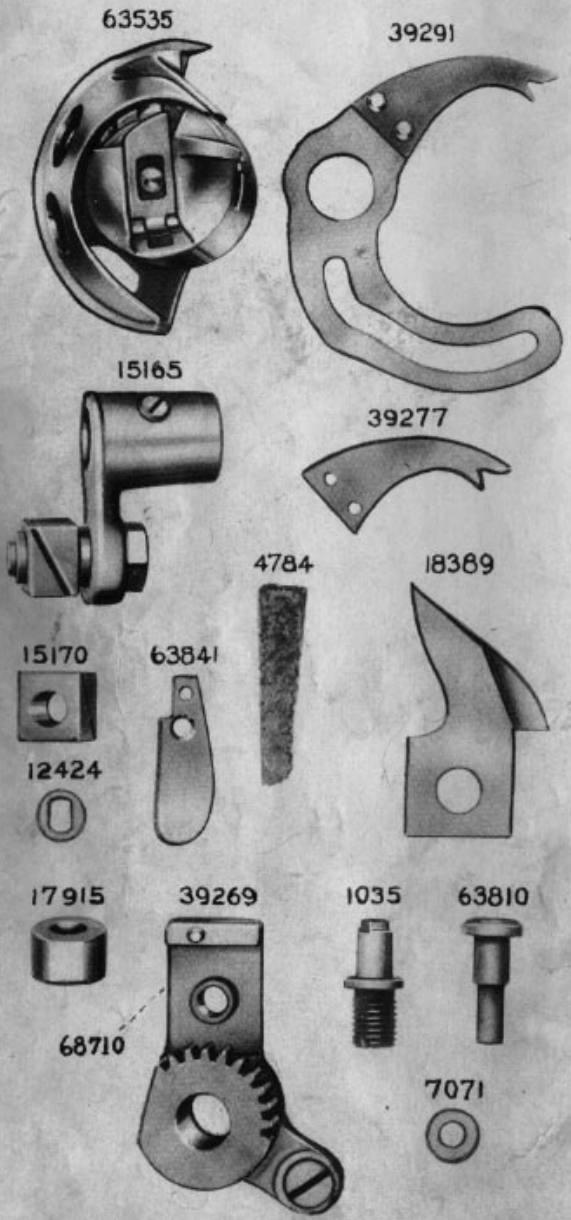
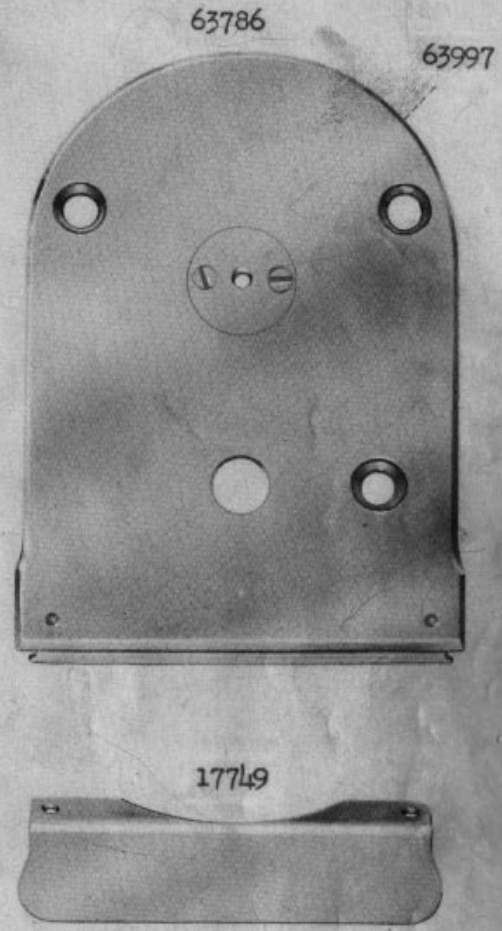

PLATE 20330—FULL SIZE



From the library of: Diamond Needle Corp

PLATE 20331—FULL SIZE

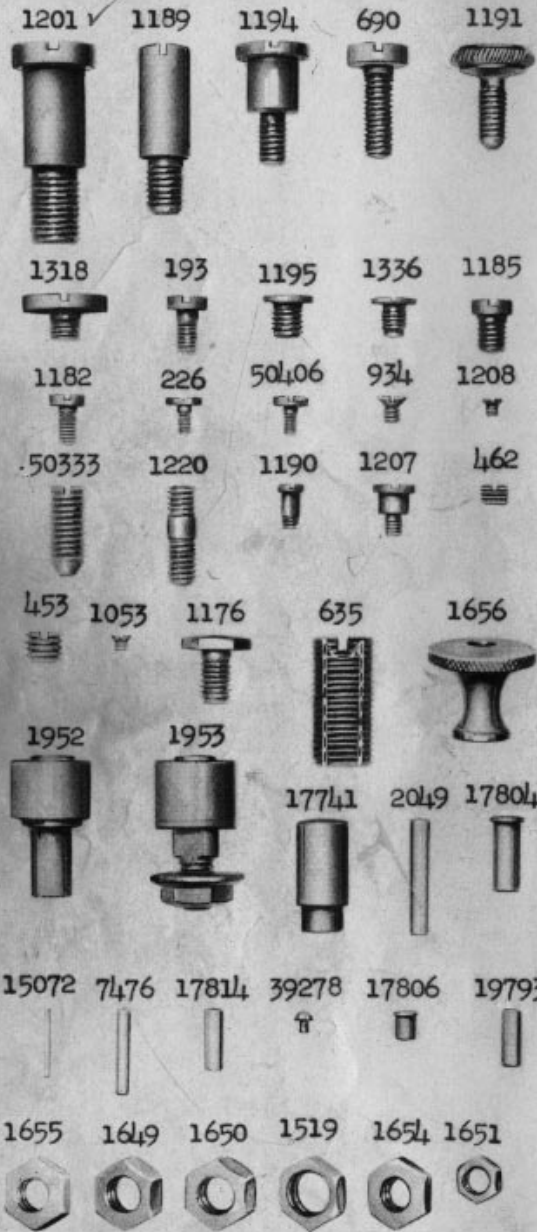

PLATE 20335—ONE-SIXTH SIZE

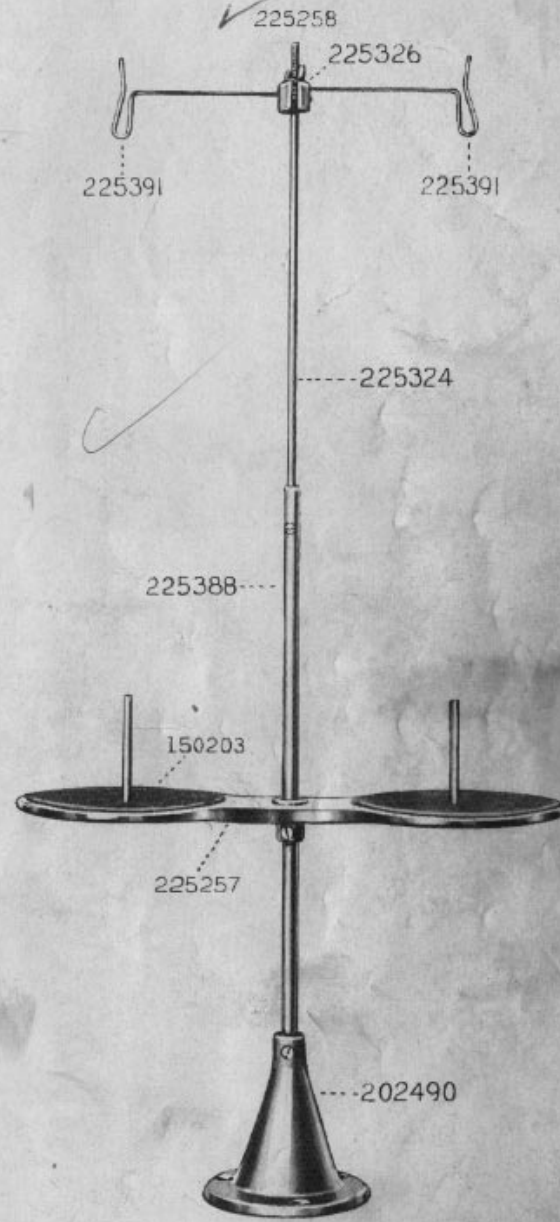

PLATE 20336-FULL SIZE

225322



37310



68708



200584



17928



8505



68715



51387



32134

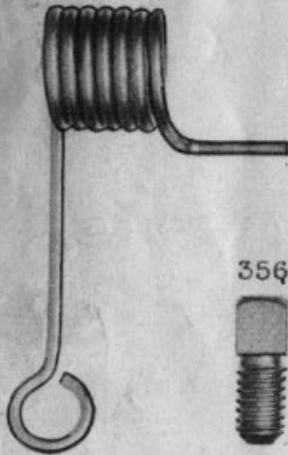

32675



356



PLATE 20337-ONE-HALF SIZE

27739



68716



68712

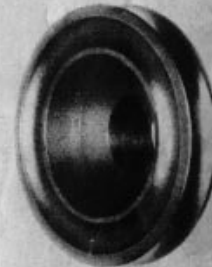

225390

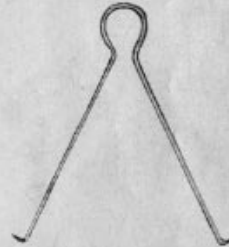

68714

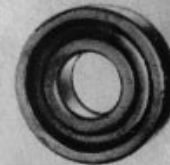

From the library of: Diamond Needle Corp

PLATE 20338-ONE-HALF SIZE

27662

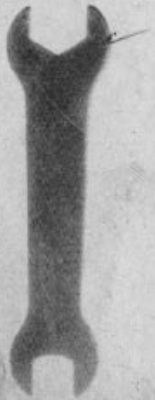

17905



120346

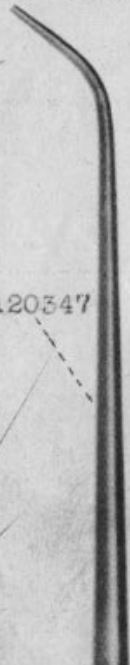

26485



120347



10875



26026



120341

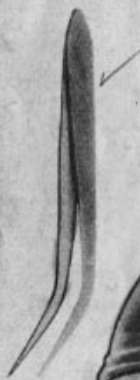

22003

4822

